

EXEDY

Excellent & Dynamic

GUÍA DE APLICACIONES
**MÉXICO
2021**



Pro-Kits

Embragues de Repuesto OEM

Made in Japan



2021 Catálogo de Productos

OEM PARA GM, FORD Y 11 MARCAS JAPONESAS



El contenido de este catálogo no contiene valor legal y la información contenida sigue propósitos informativos únicamente.

EXEDY México Aftermarket Sales, S.A. de C.V. se deslinda de cualquier responsabilidad ligada a esta publicación.

Todos los derechos reservados. Prohibida su copia, distribución, reproducción, disposición al público o cualquier otra publicación de este catálogo completo o por partes sin el consentimiento escrito de EXEDY México Aftermarket Sales, S.A. de C.V.

EXEDY Copyright ©

ACERCA DE EXEDY

EXEDY México Aftermarket Sales es una subsidiaria propiedad de EXEDY Corporation de Japón. EXEDY (Japón) fue fundada en 1923 y su manufactura de embragues y la prominente marca Daikin Clutch son reconocidas en todo el mundo por suministrar productos de calidad.

EL LÍDER MUNDIAL

Nuestra búsqueda de la perfección y garantía de seguridad son la base de nuestra famosa calidad y fiabilidad. Nuestra ingeniería avanzada y las innovaciones patentadas nos han convertido en el principal fabricante OE en el mundo de los embragues y otros componentes del sistema de tren motriz. EXEDY es el líder mundial indiscutiblemente en los deportes de automovilismo y embragues de competencia.

POLÍTICAS DE CALIDAD

EXEDY continuará proporcionando los más altos niveles de calidad de los productos y servicios que los clientes de todo el mundo aprecian. Es nuestra responsabilidad social. Vamos a mejorar continuamente el sistema de gestión de calidad para lograr los más altos niveles de satisfacción del cliente; vamos a lograr cero defectos y ser "la empresa en la cual, cero defectos son un estándar".

OE & AFTERMARKET

El Grupo EXEDY suministra embragues manuales, volantes motrices y otros componentes avanzados del sistema de transmisión a los 11 fabricantes de vehículos en Japón, así como a muchos otros fabricantes de vehículos, industrias de construcción y diversas maquinarias alrededor del mundo, incluyendo GM y Ford.



EXEDY

EXCELLENT & DYNAMIC

Global Network

● Production & Sales ● Sales ● Others



EXEDY's Worldwide Global Strategy

EXEDY's global corporate activities are expanding in America, Europe, Asia, Oceania, the Middle East, Mexico and Japan. We have structured an optimal production system from a global point of view to sustain the top level of quality. We are also continuously and actively challenging ourselves in the manufacture of new products by utilizing our solid technologies, such as motorcycle clutch production in ASEAN countries.



Head Office (Osaka)



Japanese Network

● Production ● Sales

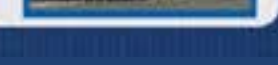

Main Products

MT

The EXEDY group companies manufacture clutch covers and clutch disc assemblies around the world. EXEDY also develops dampers with high efficient noise/vibration control and high performance motor sports clutches.



AT

EXEDY manufactures Torque Converters and Clutch Packs, providing today's drivers with a smooth and comfortable ride. The Super Squashed Torque Converter with high efficiency grounded on Hydrodynamics has been marking great advances in the American and Chinese automotive markets.



TS

EXEDY supplies uncompromising high quality products with virtually made-to-order, multi-item, small-sized production. EXEDY's power shift transmission for construction and industrial vehicles powerfully support Japanese key industries.



Motorcycle

EXEDY manufactures motorcycle clutches in the expanding markets of Southeast Asia. Utilizing the expertise accumulated in automotive clutches, EXEDY group companies in the region produce and supply Wet-type Multi-Plate Clutches and One-Way Clutches for Motorcycles.



MT

Products for Manual Transmission Automobiles

AT

Products for Automatic Transmission Automobiles

TS

Products for Construction Machinery, Industrial Vehicles and Agricultural Machinery

Clutches for Motorcycles

Friction Facings for Clutch Discs



PLATO EQUIPO ORIGINAL

Calidad respaldada por tecnología OEM.

Idénticos materiales a los utilizados en productos OEM.

Fabricado en material de fundición dúctil (FDC) antiestallido utilizado para la placa de presión.

Excelente durabilidad. Resorte de diafragma de muy bajo desgaste con tratamiento térmico especial (inducción de alta frecuencia).

DISCO EQUIPO ORIGINAL

Nueva tecnología NVR (Reducción de Ruido y Vibración) que disminuye el ruido de los engranajes y ofrece un andar silencioso y suave.

Diseño WAD (Amortiguador de Ángulo Amplio) que le permite al disco de embrague soportar mayor torque con menor fuerza. El diseño WAD es excelente para reducir el ruido de los engranajes de manera efectiva.

Mecanismo de preamortiguador que reduce el ruido en marcha lenta. Forros de fricción "creación-EXEDY" especialmente diseñados para satisfacer 100% los requisitos OEM.

EMBRAGUES DE ALTO RENDIMIENTO Y VOLANTES

Plato de alto rendimiento:

Diseñados para ofrecer gran vida útil. Los componentes están especialmente diseñados para ofrecer alto rendimiento, no son componentes OEM modificados.

Plato de alto rendimiento, 100% inspeccionado en su equilibrio giratorio y contrapeso regulado. Aunque se lo someta a condiciones de rotación del motor extremadamente alta, no genera ninguna fatiga en el motor.

Todos los componentes de los platos están diseñados para soportar el fuerte ensamblaje de diafragma con carga de abrazadera bajo condiciones extremadamente exigentes.

El material de fundición dúctil (FDC) antiestallido utilizado para la placa de presión puede soportar el calor generado por RPM extremadamente altas. También mejora la sensibilidad en los cambios de marcha (engranaje / desengranaje).



ACERCA DE EXEDY

La Corporación EXEDY de Japón (anteriormente conocida como Compañía de Fabricación Daikin) es el mayor proveedor independiente de OEM. Somos proveedores de las principales marcas de vehículos japoneses, al igual que de Ford y GM en los Estados Unidos. Además, somos el principal fabricante de embragues de competición en Japón y abastecemos a los equipos de competición de las seis industrias fabricantes de vehículos de carreras. A diferencia de nuestros competidores, nuestros embragues NO son equipo original reconstruido ni embragues en stock modificados. Los embragues de alto rendimiento y de competencia EXEDY están pensados, diseñados y construidos desde el pulido inicial como embragues de competencia, bajo las normas de los productos OEM. Las innovaciones de los productos de EXEDY están patentadas a nivel mundial y desarrolladas en nuestra propia compañía con sistemas de diseño, inspección y equipos de prueba de avanzada. Antes de que algún diseño entre en la etapa de producción, atraviesa rigurosas pruebas que simulan las más severas condiciones de manejo, lo que asegura el perfecto desempeño de su vehículo. Además, ninguna pieza sale de las instalaciones de EXEDY sin pasar por la inspección robótica y visual, lo que garantiza la calidad que respalda su vehículo.

CERTIFICACIÓN SFI



SFI Foundation Inc. establece normas especiales para piezas automotrices de competición con el fin de proteger al conductor y al espectador.

Muchas organizaciones y pistas de carreras exigen piezas aprobadas por SFI para distintas clases de competencias.

En general, a medida que los autos son más potentes y veloces, las especificaciones son cada vez más estrictas. Para garantizar que nuestros clientes puedan competir sin riesgo de ser descalificados, EXEDY ha probado y certificado la línea completa de embragues y volantes deportivos, desde los mbragues Stage 1 de primer nivel hasta nuestros excelentes embragues de discos múltiples de carbono.

EMBRAGUES DE ALTO RENDIMIENTO Y VOLANTES

Disco de fricción orgánico:

Forros de fricción exclusivamente diseñados para utilizar en carreras de alto rendimiento, otorgan alta resistencia al calor y magnífico rendimiento antiestallido.

El amortiguador deportivo está exclusivamente diseñado para soportar torques de gran torsión para utilizar en carreras de velocidad.

- 1) Pernos especialmente diseñados.
- 2) Placa de retención granallada para mejorar la dureza.
- 3) Tratamiento especial aplicado sobre la maza estriada para aumentar la dureza.
- 4) Amortiguador especialmente diseñado de ultra alta rigidez.



De fácil manejo / funcionamiento y rápida capacidad de respuesta a través de placas de desempeño amortiguado.

Disco de fricción cerametalico:

Disco de embrague de alta resistencia al calor y elevado coeficiente de fricción.

Gracias a las caras de metal liviano se alcanza un nivel más bajo de inercia, lo que mejora la respuesta de desplazamiento para cambios rápidos de velocidad.



El menor diámetro en el diseño de los 6 resortes genera alto rendimiento de torque, lo que mejora la capacidad de respuesta en los cambios. También protege la transmisión de torques con mala amortiguación.

Volante de alto rendimiento:

El volante de carrera EXEDY es un volante sólido de una sola pieza maquinada fabricado con materiales fraguados de cromomolibdeno (cromoly) que lo convierte en una pieza liviana, de baja inercia, extrema dureza y excelente equilibrio de peso.

La superficie del volante (área de contacto con el disco de embrague) posee un tratamiento térmico para eliminar compuestos químicos con el fin de optimizar el coeficiente de fricción y el agarre.



Series Hyper - Plato de disco único y múltiple:

- 1) Placa central ventilada que reduce la aceleración del calor. Esta placa central permite que las placas dobles se conviertan en triples simplemente cambiando algunos componentes.
- 2) Este anillo centra el volante y los componentes del plato con firmeza y permite precisión de balanceo del ensamblaje, lo que reduce las vibraciones originadas por un ensamblaje desequilibrado.
- 3) Mecanismo Self-Levelizer (placa doble)
 - A) Rápido desembrague.
 - B) Reduce el ruido de las piezas mecánicas en el desembrague.
 - C) Disco de embrague de prolongada vida útil por el desgaste equilibrado de los dos discos de embrague.
- 4) Con alto coeficiente de fricción y caras de metal de alta resistencia al calor, la Serie Hyper cuenta con un cuerpo superliviano con un disco de embrague de 8 pulgadas.
- 5) Gracias al exclusivo mecanismo de amortiguación, permite que la Serie Hyper del tipo tirón tenga un rendimiento de engranaje medio ultrasuave.
- 6) Fácil unión de pernos en el embrague de vehículos de tipo tirón. No se requieren modificaciones.
- 7) Ensamblaje de platos de aluminio forjado de alta rigidez, gran dureza y alta resistencia al calor.
- 8) Disco de menor diámetro con amortiguador con alta capacidad de torque exclusivamente desarrollado para la Serie Hyper Multi.

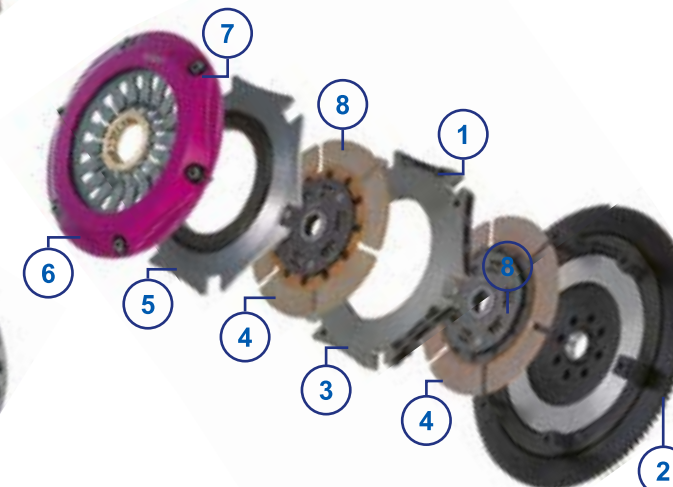

Información necesaria para elegir correctamente un embrague

Año, marca y modelo del automóvil.

¿Cuánta potencia desarrolla el vehículo?

Tamaño y código del motor.

¿Qué tipo de desplazamiento va a realizar el automóvil?

DISEÑOS OEM

PLATO OPRESOR

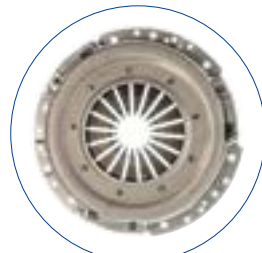

FMC617

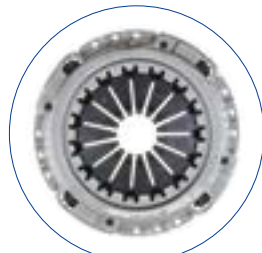

FTC803

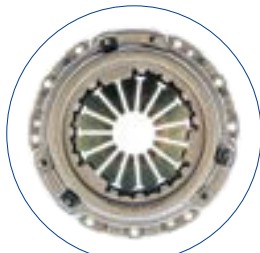

HCC531

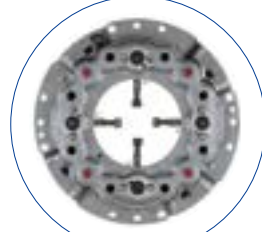

HNC567

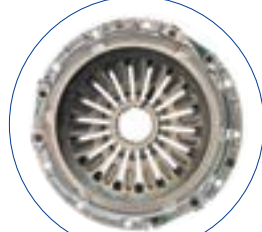

MBC618



MBC645



NSC527

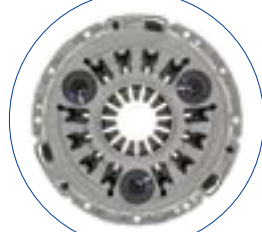

NSC815

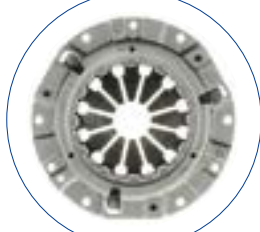

SZC564

EXEDY



HCC559U

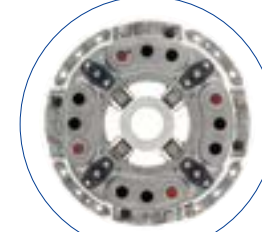

NDC524



TYC655

DISEÑOS

COLLARINES & CSC



BRG0157



BRG0220



BRG0233



BRG0186



BRG0222



BRG0237



BRG0210



BRG0224



BRG0240



BRG0216



BRG0227



BRG903

DISEÑOS OEM

DISCOS DE FRICCIÓN

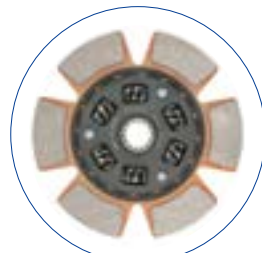

DH18D

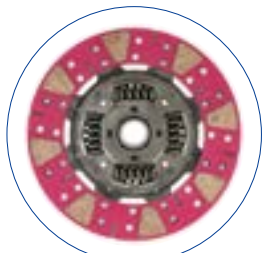

ED04HCB



HND88UM



MZD203



ND21T

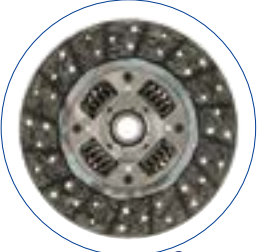

NSD053UA

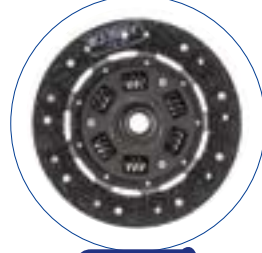

SD12H

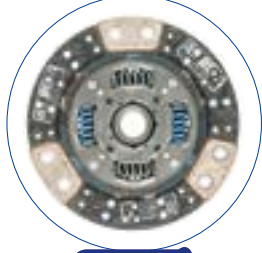

TH08SDV

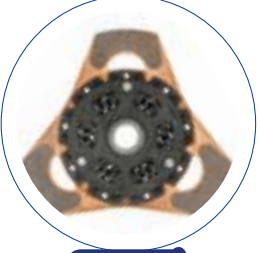

ZD07



MFD072U

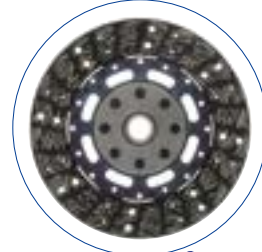

NSD134

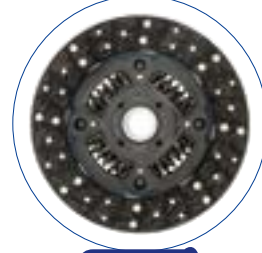

ZD14H

DISEÑOS

VOLANTES MOTRICES



FMF508



ISF100



MBF501



FMF536



ISF101



MZF503



HNF100



ISF102



NSF502



HNF101



ISF502



TYF513

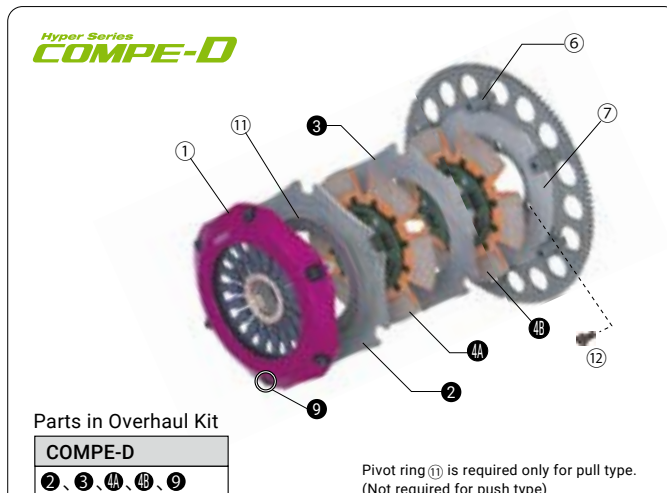
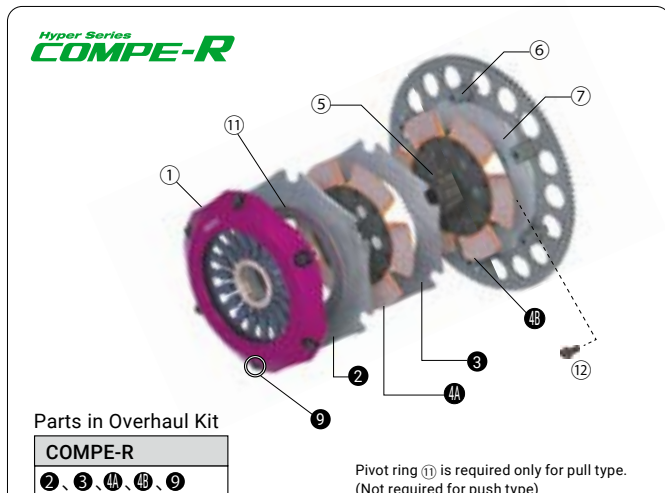
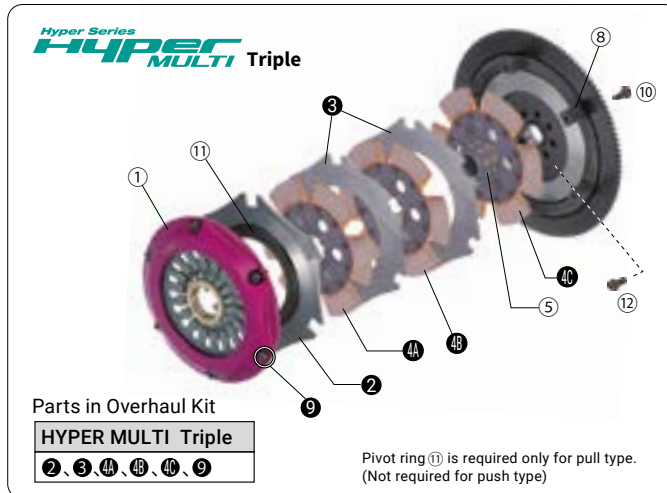
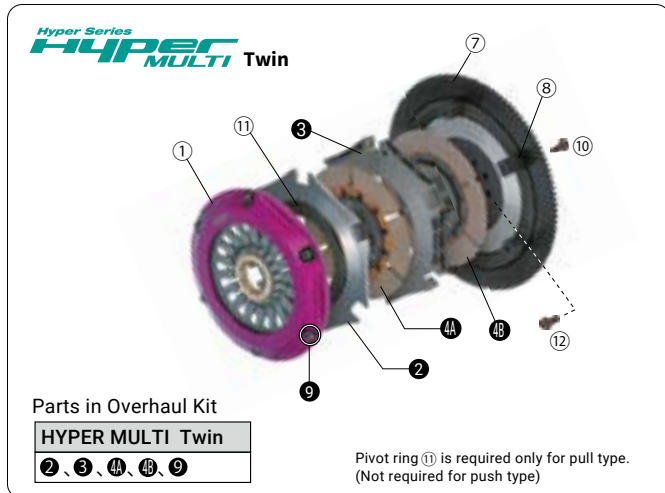
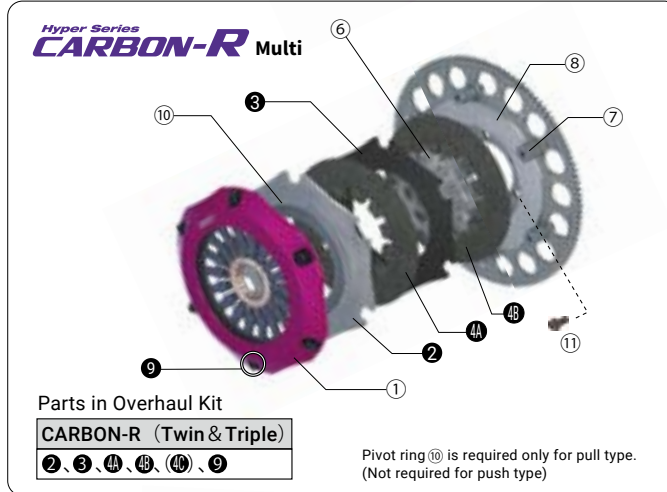
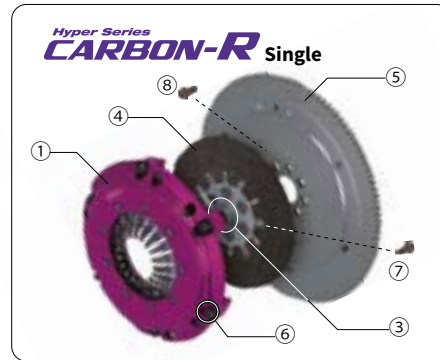
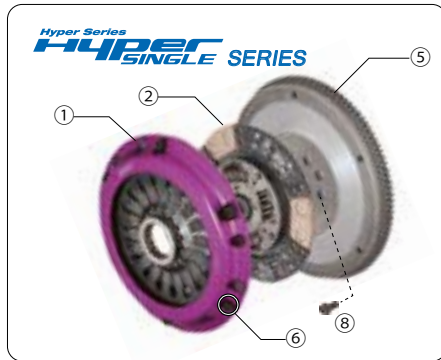

Buscador de piezas de aplicaciones Mobil-App

¿Está cansado de buscar los números de piezas de EXEDY para su aplicación? Descargue la aplicación **EXEDY Part Finder App** y tenga todo lo relacionado con EXEDY al alcance en la palma de su mano.

Encuentre el producto adecuado para su vehículo.



Siempre actualizado con las aplicaciones más recientes.



SCAN THIS QR CODE AND GET THE APP TODAY!

ÍNDICE

- 13
VEHÍCULOS NACIONALES
- 31
CAMIONES LIGEROS
- 35
VEHÍCULOS IMPORTADOS
- 39
COLLARINES & CSC
- 57
VOLANTES MOTRICES
- 65
VOLANTES MOTRICES HD
- 67
GALERÍA KITS DE EMBRAGUES

VEHÍCULOS NACIONALES



AUDI

Modelo	Motor	Versión	Año	Vel.	Pro-Kit #	Collarín	Diámetro	Estrías	Nota
A1	L4 1.4L	TFSI	10-18	6	AUK1004EX	BRG0220	219mm	28	Para Volante Plano
A3	L4 1.4L	Turbo	08-11	6	Próximamente	-	-	-	
	L4 1.4L	Turbo	09-11	6	Próximamente	-	-	-	
	L4 1.8L	Turbo	98-04	6	VWK1002	-	240mm	23	Incluye CSC
	L4 1.8L	Turbo	08-11	6	Próximamente	-	-	-	
	L4 1.8L	Quattro	98-04	6	VWK1002	-	240mm	23	Incluye CSC
	L4 2.0L		04-07	5	VWK1004	-	228mm	28	
	L4 2.0L	Turbo	05-13	6	VWK1005	-	240mm	23	Incluye CSC
	V6 3.2L		04-08	6	AUK1006	-	240mm	23	
A4	L4 1.8L	Turbo	98-05	5	VWK1001	-	228mm	23	
	L4 1.8L	Turbo	09-11	6	Próximamente	-	-	-	
	V6 2.8L		97-01	5	AUK1001	-	240mm	23	
	V6 2.8L	Quattro	97-01	5	AUK1001	-	240mm	23	
S3	L4 1.8L	Turbo	01-04	6	VWK1002	-	240mm	23	Incluye CSC
	L4 1.8L	Turbo Quattro	99-01	6	VWK1002	-	240mm	23	Incluye CSC
	L4 2.0L	Turbo	08-12	6	VWK1005	-	240mm	23	Incluye CSC
S4	V6 2.7L	Quattro	97-01	6	AUK1002	-	240mm	23	
	V6 2.7L	Turbo	00-02	6	AUK1002	-	240mm	23	Incluye CSC
	V8 4.2L		04-05	6	AUK1005	-	240mm	23	
	V8 4.2L		05-08	6	AUK1004	-	240mm	23	
TT	L4 1.8L	Quattro	98-06	6	VWK1002	-	240mm	23	Incluye CSC
	L4 2.0L	Turbo	07-11	6	VWK1005	-	240mm	23	Incluye CSC
	V6 3.2L	Turbo	08-11	6	AUK1006	-	240mm	23	

BAIC

Modelo	Motor	Versión	Año	Vel.	Pro-Kit #	Collarín	Diámetro	Estrías	Nota
D20	L4 1.5L		17-20	5	MBK1024EX	BRG0220	200mm	17	Para Volante Plano

BMW

Modelo	Motor	Versión	Año	Vel.	Pro-Kit #	Collarín	Diámetro	Estrías	Nota
325i	L6 2.5L		04-05	6	BMK1016	-	240mm	22	
328i	L6 2.8L		96-00	5	KBM11	-	240mm	10	
330i	L6 3.0L		01-03	5	BMK1017	-	240mm	10	
	L6 3.0L		04-05	5	BMK1016	-	240mm	22	
	L6 3.0L		06-07	6	BMK1012	-	240mm	22	
530i	L6 3.0L		00-04	5	BMK1017	-	240mm	10	
	L6 3.0L		04-05	6	BMK1016	-	240mm	22	
	L6 3.0L		06-10	6	BMK1012	-	240mm	22	
M3	L6 3.2L		96-99	5	BMK1003	-	240mm	10	
	L6 3.2L		01-06	6	BMK1010	-	240mm	10	
M5	V8 5.0L		00-03	6	BMK1006	-	240mm	10	
Z3	L4 1.9L		96-98	5	03028	-	215mm	10	
	L6 2.8L		97-98	5	KBM11	-	240mm	10	
	L6 2.8L		99-00	5	BMK1005	-	240mm	10	
	L6 3.0L		01-03	5	BMK1017	-	240mm	10	
	L6 3.2L		98-05	5	BMK1003	-	240mm	10	
Z4	L6 2.5L		03-05	5	BMK1015	-	240mm	22	
	L6 3.0L		03-05	6	BMK1015	-	240mm	22	
	L6 3.0L		06-07	5	BMK1012	-	240mm	22	
	L6 3.0L		07-09	5	BMK1018	-	240mm	22	
Z8	L6 2.5L		03-05	5	BMK1015	-	240mm	22	

BMW CAMIONETAS SUV, PICK UPS & VEHICULOS COMERCIALES

Modelo	Motor	Versión	Año	Vel.	Pro-Kit #	Collarín	Diámetro	Estrías	Nota
X3									
	L6 2.5i		04-06	6	BMK1016	-	240mm	22	
	L6 3.0i		04-06	6	BMK1016	-	240mm	22	
A3									
	L4 1.4L	Turbo	08-11	6	Próximamente	-			
	L4 1.4L	Turbo	09-11	6	Próximamente	-			

CBO

Modelo	Motor	Versión	Año	Vel.	Pro-Kit #	Collarín	Diámetro	Estrías	Nota
1000									
	L4 1.0L	Turbo	11-15	5	SZK1009EX	BRG0226	180mm	18	
1500									
	L4 1.1L	Diesel	2014	5	SZK1008EX	BRG438	180mm	18	

CHEVROLET

Modelo	Motor	Versión	Año	Vel.	Pro-Kit #	Collarín	Diámetro	Estrías	Nota
ASTRA									
	L4 2.0L		04-06	5	OPK1002	BRG0204	200mm	14	Incluye CSC / Serpentin
AVEO									
	L4 1.6L		08-18	5	GMK1037	BRG0151	215mm	24	
	L4 1.5L		18-21	5	Próximamente	-			
BEAT									
	L4 1.2L		18->	5	GMK1049EX	BRG0208	190mm	18	
CAMARO									
	L4 2.5L		83-86		04129	N1716SA	232mm	14	
	V6 2.8L		85-89		04129	N1716SA	232mm	14	
	V6 3.1L		90-92		04129	N1716SA	232mm	14	
	V8 5.0L	TBI	1992		04019	N1716SA	263mm	26	
	V8 5.1L		82-91		04019	N1716SA	263mm	26	
	V8 5.7L	Z28	93-97	6	Descontinuado	-	280mm	26	Tipo Jalón
	V8 5.7L	Z28, SS	98-02	6	04173	N1764SA	300mm	26	Modular
	V8 6.2L	1SS	10-15	6	GMK1036	BRG0175	290mm	26	Incluye CSC
	V8 6.2L	1SS	10-15	6	04804	BRG0175	290mm	26	Stage 1 - Racing
CAVALIER									
	L4 2.2L		90-94	5	04005	BRG431	215mm	14	
	L4 2.2L		95-00	5	04161	N8105	215mm	14	Incluye CSC
	L4 2.2L		00-04	5	KGM08	N8133	215mm	14	Incluye CSC
	L4 2.2L		02-05	5	GMK1000	N8133	225mm	14	Incluye CSC
	L4 2.3L		1995	5	04158	N8105	225mm	14	Incluye CSC
	L4 2.4L		95-00	5	04158	N8105	225mm	14	Incluye CSC
	L4 2.4L		00-02	5	KGM04	N8133	225mm	14	Incluye CSC
	V6 2.4L	Z24	95-96	5	04158	N8105	225mm	14	Incluye CSC
	V6 2.8L		87-92	5	04088	N1747SA	225mm	14	
	V6 2.8L		93-94	5	04132	N8084	225mm	14	Incluye CSC
	V6 2.8L	Z24	1992	5	04088	N1747SA	225mm	14	
	V6 2.8L	Z24	93-94	5	04132	N8084	225mm	14	Incluye CSC
CORSA									
	L4 1.4L		02-05	5	Próximamente	-	-	-	
	L4 1.8L		03-08	5	OPK1002	BRG0204	200mm	14	Incluye CSC / Serpentin
CORVETTE									
	V8 5.7L		1994	6	04142	-	280mm	26	Tipo Jalón
	V8 5.7L		94-96	6	04143	-	280mm	26	Tipo Jalón
	V8 5.7L		97-04	6	04173	N1764SA	300mm	26	Modular
	V8 6.0L		05-07	6	GMK1018	N8134	290mm	26	Auto-Ajustable
	V8 6.2L		08-11	6	04803	BRG0167	290mm	26	Stage 1 - Racing
CHEVY									
	L4 1.4L		94-02	5	GMK1042EX	BRG0209	190mm	14	
	L4 1.6L		94-12		GMK1042EX	BRG0209	190mm	14	
	L4 1.6L	Wagon	01-03	5	Próximamente	-	-	-	
CRUZE									
	L4 1.8L		10-15	5	GMK1047EX	BRG0241	230mm	20	Incluye CSC
HHR									
	L4 2.4L		06-09	5	GMK1010	BRG0143	225mm	14	Incluye CSC
MATIZ									
	L4 1.0L		04-15	5	GMK1049EX	BRG0208	190mm	18	

CHEVROLET

Modelo	Motor	Versión	Año	Vel.	Pro-Kit #	Collarín	Diámetro	Estrías	Nota
SONIC									
	L4 1.6L		12-17	5	GMK1048EX	BRG0239	215mm	24	Incluye CSC
SPARK									
	L4 1.2L		11-17	5	GMK1049EX	BRG0208	190mm	18	Para Volante Tipo Plano
	L4 1.4L		16-21	-	Próximamente	-			

CHEVROLET CAMIONETAS SUV, PICK UPS & VEHICULOS COMERCIALES

Modelo	Motor	Versión	Año	Vel.	Pro-Kit #	Collarín	Diámetro	Estrías	Nota
ASTRO									
	L4 2.5L		85-89		04129	N1716SA	232mm	14	
BLAZER									
	L4 2.0L		85-93		04130	N1716SA	232mm	14	
	L4 2.5L		85-93		04130	N1716SA	232mm	14	
	V6 2.8L		85-93		04130	N1716SA	232mm	14	
	V6 3.1L		85-93		04130	N1716SA	232mm	14	
	V6 3.1L		1995	5	KGM05	N1716SA	232mm	26	Pre-Amortiguado
	V6 3.1L		96-98	5	GMK1004	N1764SA	232mm	26	Incluye Repuesto Hidráulico
	V6 4.3L		85-93		04089	N1716SA	280mm	10	
	V6 4.3L		1994		04168	N1716SA	280mm	10	
	V6 4.3L		1995		04121	N1716SA	280mm	10	
	V6 4.3L		96-98		KGM10	N1764SA	280mm	10	Incluye Repuesto Hidráulico
	V8 5.0L		91-95		04121	N1716SA	280mm	10	
COLORADO									
	L4 2.8L		04-06	5	GMK1015	-	263mm	26	Incluye CSC
C-1500									
	L6 4.1L		94-98	4	04128	N1716SA	300mm	10	Pre-Amortiguado
	V6 4.3L	Silverado	99-13	5	KGM17	N1764SA	280mm	10	Incluye Repuesto Hidráulico
	V6 4.3L	Silverado	99-13	5	KGM21	N8134	280mm	10	
	L6 4.8L		87-93	4	04049	N1716SA	280mm	10	
	V8 5.7L		69-91		04064	N1716SA	300mm	10	
	V8 5.7L		92-95		04128	N1716SA	300mm	10	
	V8 5.7L		96-00		04170	N1764SA	305mm	10	Incluye Repuesto Hidráulico
	V8 6.5L	Diesel	92-95		04163	N1716SA	302mm	10	Para Volante Sólido
	V8 6.5L	Diesel	92-95		04163A	N1716SA	302mm	10	Incluye Volante Sólido & CSC
C-2500									
	L6 4.8L	Cheyenne	63-91	4	04049	N1716SA	280mm	10	
	V8 4.8L	Silverado	03-07	5	KGM44	N8134	302mm	10	
	V8 5.7L	C-2500	69-91		04064	N1716SA	300mm	10	
	V8 5.7L	C-2500	92-95		04128	N1716SA	300mm	10	
	V8 5.7L	C-2500	96-00		04170	N1764SA	305mm	10	Incluye Repuesto Hidráulico
	V8 5.7L	Cheyenne	87-95	4	04128	N1716SA	300mm	10	
	V8 5.7L	Silverado SLX	94-98	4	04128	N1716SA	300mm	10	
	V8 5.7L	Silverado SLX	99-02		04087	N1716SA	302mm	10	
	V8 5.7L	400SS	92-00	4	04128	N1716SA	300mm	10	Pre-Amortiguado
	V8 6.5L	Turbo Diesel	92-95		04163	N1716SA	302mm	10	Para Volante Sólido
	V8 6.5L	Turbo Diesel	92-95		04163A	N1716SA	302mm	10	Incluye Volante Sólido
	V8 7.4L	HD	96-00	5	04154	N1764SA	302mm	10	Para Volante Sólido
	V8 7.4L	HD	96-00	5	04154A	N1764SA	302mm	10	Incluye Repuesto Hidráulico
	V8 7.4L	HD	96-00	5	04154A	N1764SA	302mm	10	Incluye Volante Sólido & Repuesto Hidráulico
C-3500									
	V8 5.7L		69-91		04064	N1716SA	300mm	10	
	V8 5.7L		92-98	4	04128	N1716SA	300mm	10	Pre-Amortiguado
	V8 5.7L		99-00	4	04087	N1716SA	302mm	10	
	V8 5.7L		01-07	5	04170	N1764SA	305mm	10	Incluye Repuesto Hidráulico
	V8 5.7L	HD Silverado	01-07	5	GMK1019	-	295mm	10	Incluye CSC
	V8 6.0L	Silverado	08-13	5	GMK1009	N8134	290mm	10	
	V8 6.5L	Diesel	92-95		04163	N1716SA	302mm	10	Para Volante Sólido
	V8 6.5L	Diesel	92-95		04163A	N1716SA	302mm	10	Incluye Volante Sólido & CSC
	V8 7.4L	HD	97-00	5	04154	N1764SA	302mm	10	Para Volante Sólido
	V8 7.4L	HD	97-00	5	04154A	N1764SA	302mm	10	Incluye Repuesto Hidráulico
	V8 7.4L	HD	97-00	5	04154A	N1764SA	302mm	10	Incluye Volante Sólido & Repuesto Hidráulico
	V8 8.1L	HD Silverado	01-06	5	GMK1019	-	295mm	10	Incluye CSC
C-4000									
	V8 5.7L		96-00		04171	N1764SA	290mm	10	Incluye Repuesto Hidráulico

CHEVROLET CAMIONETAS SUV, PICK UPS & VEHICULOS COMERCIALES

Modelo	Motor	Versión	Año	Vel.	Pro-Kit #	Collarín	Diámetro	Estrías	Nota
JIMMY									
	L4 2.5L		85-93		04130	N1716SA	232mm	14	
	V6 2.8L		85-93		04130	N1716SA	232mm	14	
	V6 4.3L		85-93		04089	N1716SA	280mm	10	
	V6 4.3L		94-95		04121	N1716SA	280mm	10	
	V6 4.3L		96-98		KGM10	N1764SA	280mm	10	Incluye Repuesto Hidráulico
	V8 5.0L		91-95		04121	N1716SA	280mm	10	
KODIAK									
	V8 6.0L		94-00		KGM40	-	330mm	10	
	L6 7.0L		97-00		KGM40	-	330mm	10	
	L6 7.2L	Diesel	01-08		KGM42	-	356mm	10	Tipo Jalón
LUV									
	L4 2.2L		99-05	5	ISK1009EX	BRG0176	215mm	24	
	L4 2.3L		97-98	5	ISK1003EX	BRG403	215mm	24	Volante Tipo Plano
MERIVA									
	L4 1.8L		04-08	5	OPK1002	BRG0204	200mm	14	Incluye CSC / Serpentin
MICROBUS									
	V8 5.7L		85-96	4	04128	N1716SA	300mm	10	Pre-Amortiguado
P-30									
	V8 5.7L		87-96	4	04064	N1716SA	300mm	10	
	V8 5.7L		87-96	4	04105	N1716SA	300mm	10	Diafragma de 12" Cerametalico HD
	V8 5.7L		97-98	4	04128	N1716SA	300mm	10	Pre-Amortiguado
	V8 5.7L		99-03	4	04087	N1716SA	302mm	10	
S-10									
	L4 2.2L	OHV	94-95	5	04138	N1716SA	232mm	26	Pre-Amortiguado
	L4 2.2L		1996	5	KGM05	N1716SA	232mm	26	Pre-Amortiguado
	L4 2.2L		96-04	5	GMK1004	N1764SA	232mm	26	Incluye Repuesto Hidráulico
	L4 2.5L		85-93		04130	N1716SA	232mm	14	
	V6 2.8L		85-93		04130	N1716SA	232mm	14	
	V6 3.1L		85-93		04130	N1716SA	232mm	14	
	V6 4.3L		90-93		04089	N1716SA	280mm	10	
	V6 4.3L		94-95		04168	N1716SA	280mm	10	
S-15									
	L4 2.5L		85-93		04130	N1716SA	232mm	14	
	V6 2.8L		85-93		04130	N1716SA	232mm	14	
	V6 4.3L		90-93		04089	N1716SA	280mm	10	
SIERRA									
	V6 4.3L		85-91		04089	N1716SA	280mm	10	
	V6 4.3L		92-95		04121	N1716SA	280mm	10	
	V6 4.3L		96-98		KGM10	N1764SA	280mm	10	Incluye Repuesto Hidráulico
	V8 5.0L		91-95		04121	N1716SA	280mm	10	
	V8 5.7L		85-95		04122	N1716SA	302mm	10	
	V8 6.2L		85-95		04122	N1716SA	302mm	10	
	V8 7.4L		85-95		04122	N1716SA	302mm	10	
SILVERADO									
	V6 4.3L		85-91		04089	N1716SA	280mm	10	
	V6 4.3L		92-95		04121	N1716SA	280mm	10	
	V6 4.3L		96-98		KGM10	N1764SA	280mm	10	Incluye Repuesto Hidráulico
	V6 4.3L		99-13	5	KGM17	N1764SA	280mm	10	Incluye Repuesto Hidráulico
	V6 4.3L		99-13	5	KGM21	N8134	280mm	10	
	V8 4.8L		03-07	5	KGM44	N8134	302mm	10	
	V8 5.0L		91-95		04121	N1716SA	280mm	10	
	V8 5.7L	TBI	96-98	4	04128	N1716SA	300mm	10	Pre-Amortiguado
	V8 5.7L	SLX	99-02		04087	N1716SA	302mm	10	
	V8 6.0L		08-13	5	GMK1009	N8134	290mm	10	
TORNADO									
	L4 1.8L		04-12	5	OPK1002	BRG0204	200mm	14	Incluye CSC / Serpentin
TRACKER									
	L4 1.6L		92-97	5	04108	BRG0127	200mm	20	
	L4 1.6L		98-00	5	04137	-	215mm	20	
	L4 2.0L		99-03	5	KSZ04	BRG0127	225mm	20	
TRAX									
	L4 1.8L		15-17	5	GMK1050EX	BRG0239	230mm	20	Incluye CSC

DODGE / CHRYSLER

Modelo	Motor	Versión	Año	Vel.	Pro-Kit #	Collarín	Diámetro	Estrías	Nota
ATOS									
	L4 1.0L		01-04	5	HYK1015EX	BRG0211	180mm	24	
	L4 1.1L		05-11	5	HYK1015EX	BRG0211	180mm	24	
ATTITUDE									
	L4 1.2L		15-19	5	MBK1023	BRG0227	190mm	19	
	L4 1.4L		06-11	5	HYK1000	BRG0109	215mm	20	
	L4 1.4L		12-13	5	HYK1009EX	BRG0177	215mm	20	
	L4 1.4L		2014	5	HYK1016EX	BRG0177	200mm	20	
	L4 1.6L		10-11	5	HYK1016EX	BRG0177	200mm	20	
AVENGER									
	L4 2.0L		95-99	5	05085	N8132	230mm	17	Modular
	L4 2.0L		08-10	5	CRK1017	-	230mm	17	Modular, Incluye CSC
CALIBER									
	L4 1.8L		07-08	5	CRK1017	-	230mm	17	Modular, Incluye CSC
	L4 2.0L		2007		CRK1017	-	230mm	17	Modular, Incluye CSC
	L4 2.4L		08-12	5	CRK1017	-	230mm	17	Modular, Incluye CSC
CROSSFIRE									
	V6 3.2L		04-06	6	CRK1009	-	240mm	26	Incluye CSC
NEON									
	L4 2.0L		94-99	5	05076	N8132	230mm	17	
	L4 2.0L		96-00	5	05085	N8132	230mm	17	Modular
	L4 2.0L		98-05	5	05085	N8132	230mm	17	Modular
	L4 2.0L	RT	01-04	5	05085	N8132	230mm	17	Modular
	L4 2.4L	SRT-4	04-05	5	CRK1001	-	240mm	17	Modular
PT CRUISER									
	L4 2.4L		01-10	5	KCH05	N8132	230mm	17	Modular
	L4 2.4L	GT	03-05	5	CRK1000	-	240mm	26	Modular
STRATUS									
	L4 2.0L		95-00	5	05076	N8132	230mm	17	
	L4 2.0L		95-06	5	05085	N8132	230mm	17	Modular
	L4 2.4L		01-05	5	MBK1000	BRG210	225mm	20	
VERNA									
	L4 1.5L		04-06	5	05091	BRG0109	200mm	20	
	L4 1.6L		04-06	5	HYK1000	BRG0109	215mm	20	
VIPER									
	V10 8.3L		03-06	6	05088	N1754	311mm	26	

DODGE / CHRYSLER CAMIONETAS SUV, PICK UPS & VEHICULOS COMERCIALES

Modelo	Motor	Versión	Año	Vel.	Pro-Kit #	Collarín	Diámetro	Estrías	Nota
DAKOTA									
	L4 2.5L		88-91		05037	N1756SA	232mm	23	
	L4 2.5L		1992		05066	N8074	232mm	19	
	L4 2.5L		93-96	5	05070	N8074	232mm	10	
	L4 2.5L		97-98	5	05089	N8074	232mm	14	
	L4 2.5L		99-02		05104	N8074	232mm	19	
	V6 3.7L		2006		CRK1010	N8074	302mm	10	
	V6 3.9L		87-91		05031	N1756SA	263mm	23	
	V6 3.9L		2000	5	KDG02	N8074	265mm	10	
	V6 3.9L		01-09		CRK1010	N8074	302mm	10	
	V8 4.7L		94-00		05072	N8074	302mm	10	
	V8 4.7L		01-07		CRK1010	N8074	302mm	10	
	V8 5.2L		94-00	4	05072	N8074	302mm	10	
DODGE 1000									
	L4 2.4L	Van 1000	08-09	5	05041	BRG350	225mm	23	
H-100									
	L4 2.4L		03-05	5	HYK1011EX	BRG0214	240mm	23	Volante Tipo Plano
	L4 2.4L	Van 1000	08-09	5	05041	BRG350	225mm	23	
	L4 2.4L		12-14	5	HYK1010EX	BRG0214	250mm	23	Volante Tipo Caja
	L4 2.5L	Diesel	06-12	5	HYK1011EX	BRG0214	240mm	23	Volante Tipo Plano
	L4 2.5L	Diesel	10-14	5	HYK1010EX	BRG0214	250mm	23	Volante Tipo Caja
MICROBUS									
	V8 5.9L		88-91	4	05038	N1756SA	280mm	23	
	V8 5.9L		92-93	4	05063	N8074	280mm	19	
MINI RAM VAN									
	L4 2.2L		91-92		05057	N8050	232mm	17	
	L4 2.5L		93-95		05069	N8050	228mm	17	Modular

DODGE / CHRYSLER CAMIONETAS SUV, PICK UPS & VEHICULOS COMERCIALES

Modelo	Motor	Versión	Año	Vel.	Pro-Kit #	Collarín	Diámetro	Estrías	Nota
MINI RAM VAN									
	V6 3.0L		90-94		05069	N8050	228mm	17	Modular
	V6 3.3L		93-94		05069	N8050	228mm	17	Modular
NITRO									
	V6 3.7L		2007	5	CRK1006	-	265mm	10	
RAM 50									
	L4 2.0L		81-90		05011	BRG423	215mm	23	
RAM 1500									
	V6 3.7L		04-13	5	KDG01	N8074	302mm	10	
	V6 3.9L		94-00	4	05080	N8074	302mm	10	
	V6 3.9L		01-05	5	KDG01	N8074	302mm	10	
	V8 4.7L		02-07	5	KDG01	N8074	302mm	10	
	V8 5.2L		94-00	4	05072	N8074	302mm	10	
	V8 5.2L		2001		KDG01	N8074	302mm	10	
RAM 2500									
	V8 4.7L		02-07	5	KDG01	N8074	302mm	10	
	V8 5.2L		94-00	4	05072	N8074	302mm	10	
	V8 5.2L		2001		KDG01	N8074	302mm	10	
	V8 5.7L		03-08	5	CRK1008	-	290mm	10	
	V8 5.9L		94-00		05072	N8074	302mm	10	Reemplaza Sist. OE 11'
	V8 5.9L		00-02	5	05074	N8074	302mm	10	
RAM 3500									
	V8 4.7L		02-07	5	KDG01	N8074	302mm	10	
	V8 5.2L		2001		KDG01	N8074	302mm	10	
	V8 5.7L		03-08	5	CRK1008	-	290mm	10	
	V8 5.9L		96-00		05072	N8074	302mm	10	Reemplaza Sist. OE 11'
	V8 5.9L		00-02	5	05074	N8074	302mm	10	
RAM 4000									
	V8 5.7L		03-10	5	CRK1008	-	290mm	10	
	V8 5.9L		96-00	4	05072	N8074	302mm	10	Reemplaza Sist. OE 11'
	V8 5.9L		00-02	5	05074	N8074	302mm	10	
	L6 5.9L	Diesel	05-09	6	CRK1005FW	BRG0168	315mm	10	Incluye Volante Sólido & CSC
	L6 5.9L	Diesel	05-09	6	CRK1005FWHD	BRG0168	315mm	10	Versión HD, Incluye Volante Sólido & CSC
	L6 6.7L	Diesel	11-13	6	CRK1005FW	BRG0168	315mm	10	Incluye Volante Sólido & CSC
	L6 6.7L	Diesel	11-13	6	CRK1005FWHD	BRG0168	315mm	10	Versión HD, Incluye Volante Sólido & CSC
	V10 8.0L		94-97	4	05073	BRG0168	311mm	10	
	V10 8.0L		98-03	4	05092	BRG0168	311mm	10	
RAM SRT-10									
	V10 8.3L	SRT-10	04-06	6	05088	N1754	311mm	26	
STAREX									
	L4 2.4L		18->	5	HYK1010EX	BRG0214	250mm	23	Volante Tipo Caja

FAW / GIANT MOTORS

Modelo	Motor	Versión	Año	Vel.	Pro-Kit #	Collarín	Diámetro	Estrías	Nota
F5									
	L4 1.5L		08-11	5	TYK1525EX	BRG0227	200mm	19	
GF 8									
	L4 1.0L		07-12	5	SZK1009EX	BRG0226	180mm	18	
	L4 1.0L		13-16	5	SZK1008EX	BRG438	180mm	18	
GF 900									
	L4 1.0L		07-12	5	SZK1009EX	BRG0226	180mm	18	
	L4 1.0L		13-16	5	SZK1008EX	BRG438	180mm	18	

FORD

Modelo	Motor	Versión	Año	Vel.	Pro-Kit #	Collarín	Diámetro	Estrías	Nota
CONTOUR									
	L4 2.0L		95-01	5	07136	BRG0101	240mm	23	Incluye CSC
	V6 2.5L		95-01	5	07137	BRG0102	240mm	23	Incluye CSC
	V6 2.5L	SVT	95-01	5	07137	BRG0102	240mm	23	Incluye CSC
COURIER									
	L4 1.6L		01-12	5	FMK1029EX	CSC100	190mm	17	Incluye CSC C/Adaptador (11.1mm ó 9.5 mm)
ESCORT									
	L4 1.8L		95-96		07075	BRG453	200mm	20	
	L4 2.0L		97-01	5	KFM16	BRG452	225mm	22	

FORD

Modelo	Motor	Versión	Año	Vel.	Pro-Kit #	Collarín	Diámetro	Estrías	Nota
FIESTA									
	L4 1.6L		01-10	5	FMK1029EX	CSC100	190mm	17	Incluye CSC C/Adaptador (11.1mm ó 9.5 mm)
	L4 1.6L		11-19	5	FMK1032	BRG0231	220mm	17	Incluye CSC / Embrague Convencional
FIGO									
	L4 1.5L		16-20	5	FMK1032	BRG0231	220mm	17	Incluye CSC / Embrague Convencional
FOCUS									
	L4 2.0L		2000	5	KFM02	BRG0107	219mm	17	Incluye CSC
	L4 2.0L		99-04	5	KFM01	BRG0108	228mm	23	Incluye CSC
	L4 2.0L	SVT	02-03	6	FMK1005	BRG0108	240mm	14	Inc. DMF & Volante Dual & CSC
	L4 2.0L	ZX3	00-05	5	KFM01	BRG0108	228mm	23	Incluye CSC
	4 2.0L	Argentina	05-08	5	FMK1027E	CSC100	220mm	17	Incluye CSC C/Adaptador (11.1mm ó 9.5 mm)
	L4 2.0L	Europa	05-08	5					Próximamente
	L4 2.0L		07-11	5					Próximamente
	L4 2.0L	ST-Turbo	13-15	6	FMK1034	BRG0242	240mm	23	Diseño EXEDY / No Auto-Ajustable
FUSIÓN									
	L4 2.3L	S & SE	07-08	5	FMK1004	BRG452	225mm	22	
	L4 2.5L		09-12	6	MZK1008	BRG452	230mm	22	
IKON									
	L4 1.6L		03-11	5	FMK1029EX	CSC100	190mm	17	Incluye CSC C/Adaptador (11.1mm ó 9.5 mm)
KA									
	L4 1.6L		01-08	5	FMK1029EX	CSC100	190mm	17	Incluye CSC C/Adaptador (11.1mm ó 9.5 mm)
MUSTANG									
	V6 3.8L		94-04	5	07114	N1714SA	280mm	10	
	V6 4.0L	GT	05-10	5	07808FW	BRG0159	225mm	22	Incluye Volante Deportivo & CSC
	V8 4.6L	GT	96-01	5	07042	N1714SA	265mm	10	
	V8 4.6L	GT	01-04	5	KFM09	N1714SA	280mm	10	
	V8 4.6L	GT	05-10	5	FMK1011	BRG0159	280mm	10	Incluye CSC
	V8 4.6L	GT	05-10	5	FMK1012	BRG0159	280mm	26	Incluye CSC
	V8 5.0L		85-97	5	07042	N1714SA	265mm	10	
	V8 5.0L	GT	11-16	6	FMK1026	BRG0186	280mm	23	Incluye CSC
	V8 5.4L	GT500	08-13	6	07953PFW	BRG0159	280mm	26	Incluye Volante Deportivo & CSC
	V8 5.8L	GT500	08-14	6	07953PFW	BRG0159	280mm	26	Incluye Volante Deportivo & CSC
MYSTIQUE									
	L4 2.0L		95-01	5	07136	BRG0101	240mm	23	Incluye CSC
	V6 2.5L		95-01	5	07137	BRG0102	240mm	23	Incluye CSC

FORD CAMIONETAS SUV, PICK UPS & VEHICULOS COMERCIALES

Modelo	Motor	Versión	Año	Vel.	Pro-Kit #	Collarín	Diámetro	Estrías	Nota
AEROSTAR									
	V6 3.0L		88-92		07054	N1754	225mm	23	Repuesto Hidráulico
	V6 3.0L		93-94		07099	N8096	225mm	23	Repuesto Hidráulico
BRONCO									
	L6 4.9L		88-92	5	07056	N1754	228mm	10	Repuesto Hidráulico
	L6 4.9L		88-92	5	07057	N1754	280mm	10	Repuesto Hidráulico
	L6 4.9L		83-92	4	07016	N1714SA	228mm	10	
	L6 4.9L		93-96	4	07097	N8096	280mm	10	Repuesto Hidráulico
	L6 5.0L		88-92	5	07057	N1754	280mm	10	Repuesto Hidráulico
	L6 5.0L		93-96	4	07097	N8096	280mm	10	Repuesto Hidráulico
	L6 5.8L		88-92	5	07057	N1754	280mm	10	Repuesto Hidráulico
	L6 5.8L		93-96	4	07097	N8096	280mm	10	Repuesto Hidráulico
CUSTOM									
	V8 5.0L	XLT	91-97	4	FMK1031EX	N1714SA	280mm	10	
	V8 5.8L	XLT	91-97	4	FMK1031EX	N1714SA	280mm	10	
ECOSPORT									
	L4 2.0L		04-12	5	FMK1027E	CSC100	220mm	17	Incluye CSC C/Adaptador

FORD CAMIONETAS SUV, PICK UPS & VEHICULOS COMERCIALES

Modelo	Motor	Versión	Año	Vel.	Pro-Kit #	Collarín	Diámetro	Estrías	Nota
ESCAPE									
	L4 2.0L		01-04		KFM16	BRG452	225mm	22	
	L4 2.3L	Americana	05-08		FMK1019	N8134	240mm	23	Incluye CSC
	L4 2.5L	Nacional	09-12		FMK1019	N8134	240mm	23	Incluye CSC
EXPLORER									
	V6 4.0L		90-92		07077	N1754	254mm	23	Repuesto Hidráulico
	V6 4.0L		93-97		07096	N8096	254mm	23	Repuesto Hidráulico
	V6 4.0L		98-00		07139	N8096	257mm	23	Auto-Ajustable & Repuesto Hidráulico
	V6 4.0L		01-03		FMK1000	N8096	257mm	23	Auto-Ajustable & Repuesto Hidráulico
E-250									
	V6 4.2		98-99	5	FMK1020	N8134	290mm	10	Repuesto Hidráulico
E-350									
	V8 5.4L		98-99		07144	N8126	305mm	10	
F-100									
	L4 2.5L		98-03	5	KFM06CSC	-	228mm	23	No Autoajustable, Incluye CSC
	V6 3.0L		97-03	5	KFM06CSC	-	228mm	23	No Autoajustable, Incluye CSC
	L6 4.9L		88-92	5	07056	N1754	228mm	10	Repuesto Hidráulico
	L6 4.9L		83-93	4	07016	N1714SA	228mm	10	
	V8 5.0L		84-86	4	07016	N1714SA	228mm	10	
	V8 5.0L		87-92	5	07057	N1754	280mm	10	Repuesto Hidráulico
	V8 5.8L		84-86	4	07016	N1714SA	228mm	10	
	V8 5.8L		87-92	5	07057	N1754	280mm	10	Repuesto Hidráulico
F-150									
	V6 3.8L		91-97	4	07097	N8096	280mm	10	Repuesto Hidráulico
	L4 4.0L		93-98		07096	N8096	228mm	23	Repuesto Hidráulico
	V6 4.2L	OHV	97-99	5	07129	N8096	290mm	10	Repuesto Hidráulico
	V6 4.2L	OHV	97-99	5	FMK1021	N8096	290mm	10	Incluye Volante Sólido & Repuesto Hidráulico
	V6 4.2L		98-09	5	FMK1020	N8134	290mm	10	Repuesto Hidráulico
	V8 4.6L		97-06	5	FMK1020	N8134	290mm	10	Repuesto Hidráulico
	L6 4.9L		88-92	5	07056	N1754	228mm	10	Repuesto Hidráulico
	L6 4.9L		88-92	5	07057	N1754	280mm	10	Repuesto Hidráulico
	L6 4.9L		83-92	4	07016	N1714SA	228mm	10	
	L6 4.9L		93-97	5	07097	N8096	280mm	10	Repuesto Hidráulico
	V8 5.0L		65-91	4	FMK1030EXMX	BRG0213	280mm	10	Diseño EXEDY- Diafragma
	V8 5.0L		87-92	5	07057	N1754	280mm	10	Repuesto Hidráulico
	V8 5.4L		99-04		07144	N8126	305mm	10	
	V8 5.8L		87-92	5	07057	N1754	280mm	10	Repuesto Hidráulico
	V8 5.8L		93-96	5	07097	N8096	280mm	10	Repuesto Hidráulico
F-200									
	V8 5.0L		65-91	4	FMK1030EXMX	BRG0213	280mm	10	Diseño EXEDY- Diafragma
	V8 5.8L		65-91	4	FMK1030EXMX	BRG0213	280mm	10	Diseño EXEDY- Diafragma
F-250									
	V6 4.2L		97-98		07129	N8096	290mm	10	Auto-Ajustable & CSC
	V6 4.2L		99-09		FMK1020	N8134	290mm	10	Repuesto Hidráulico
	V8 4.6L		97-09		FMK1020	N8134	290mm	10	Repuesto Hidráulico
	L6 4.9L		88-93	5	07057	N1754	280mm	10	Repuesto Hidráulico
	L6 4.9L		93-97	5	07097	N8096	280mm	10	Repuesto Hidráulico
	V8 5.0L		65-91	4	FMK1030EXMX	BRG0213	280mm	10	Diseño EXEDY- Diafragma
	V8 5.0L		88-92	5	07056	N1754	228mm	10	Repuesto Hidráulico
	V8 5.0L		92-97		FMK1031EX	N1714SA	280mm	10	
	V8 5.8L		65-91	4	FMK1030EXMX	BRG0213	280mm	10	Diseño EXEDY- Diafragma
	V8 5.8L		88-92	5	07056	N1754	228mm	10	Repuesto Hidráulico
	V8 5.8L		93-97	5	07097	N8096	280mm	10	Repuesto Hidráulico
	V8 5.8L	Lobo	1995		Próximamente	-	-	10	-
	V8 6.0L	Super Duty	03-07	6	FMK1016	-	330mm	10	Auto-Ajustable
	V8 6.4L	Super Duty	08-10	6	FMK1016	-	330mm	10	Auto-Ajustable
	V8 7.3L	Diesel	88-94		07100B	N1753	302mm	10	Incluye Volante & Repuesto Hidráulico
	V8 7.3L		94-97		FMK1007	N1753	330mm	10	Incluye Volante Sólido & Repuesto Hidráulico
	V8 7.3L	Super Duty	99-03	6	FMK1008	N8126	330mm	10	Incluye Volante Sólido & Repuesto Hidráulico
	V8 7.5L		1998		FMK1007	N1753	330mm	10	Inc. Volante Sólido & Repuesto Hidráulico

FORD CAMIONETAS SUV, PICK UPS & VEHICULOS COMERCIALES

Modelo	Motor	Versión	Año	Vel.	Pro-Kit #	Collarín	Diámetro	Estrías	Nota
F-350									
	V8 4.7L		65-91	4	FMK1030EXMX	BRG0213	280mm	10	Diseño EXEDY- Diafragma
	L6 4.9L		88-92	5	07057	N1754	280mm	10	Repuesto Hidráulico
	L6 4.9L		88-92	4	07016	N1714SA	228mm	10	
	V8 5.0L		65-91	4	FMK1030EXMX	BRG0213	280mm	10	Diseño EXEDY- Diafragma
	V8 5.0L		88-92	5	07056	N1754	228mm	10	Repuesto Hidráulico
	V8 5.0L		93-97		FMK1031EX	N1714SA	280mm	10	-
	V8 5.4L	Super Duty	99-10	5	07144	N8126	305mm	10	
	V6 5.8L		88-92	5	07057	N1754	280mm	10	Repuesto Hidráulico
	V8 5.8L		65-91	4	FMK1030EXMX	BRG0213	280mm	10	Diseño EXEDY- Diafragma
	V8 5.8L		92-98		FMK1031EX	N1714SA	280mm	10	-
	V8 6.0L	Super Duty	03-07	6	FMK1016	-	330mm	10	Auto-Ajustable
	V8 6.4L	Super Duty	08-10	6	FMK1016	-	330mm	10	Auto-Ajustable
	V8 7.3L	Diesel	88-94		07100B	N1753	302mm	10	Incluye Volante & Repuesto Hidráulico
	V8 7.3L	Super Duty	99-03	6	FMK1008	N8126	330mm	10	Incluye Volante Sólido & Repuesto Hidráulico

FORD CAMIONES

Modelo	Motor	Versión	Año	Vel.	Pro-Kit #	Collarín	Diámetro	Estrías	Nota
F-450									
	V8 5.0L		88-92	5	07057	N1754	280mm	10	Repuesto Hidráulico
	V8 5.8L		88-92	5	07057	N1754	280mm	10	Repuesto Hidráulico
	V8 6.0L	Super Duty	04-07	6	FMK1016	-	330mm	10	Auto-Ajustable
	V8 6.4L	Super Duty	08-10	6	FMK1016	-	330mm	10	Auto-Ajustable
	V10 6.8L	Super Duty	99-03	5	KFM21	N8126	305mm	10	Auto-Ajustable
	V10 6.8L	Super Duty	04-09	5	FMK1018	-	305mm	10	Auto-Ajustable
	V8 7.3L	Super Duty	88-94		07100B	N1753	302mm	10	Incluye Volante & Repuesto Hidráulico
	V8 7.3L	Super Duty	94-98	5	FMK1007	N1753	330mm	10	Incluye Volante Sólido & Repuesto Hidráulico
	V8 7.3L	Super Duty	99-03	6	FMK1008	N8126	330mm	10	Incluye Volante Sólido & Repuesto Hidráulico
	V8 7.5L	Super Duty	1998	5	FMK1007	N1753	330mm	10	Inc. Volante Sólido
F-550									
	V8 6.0L	Super Duty	03-07	6	FMK1016	-	330mm	10	Auto-Ajustable
	V10 6.4L	Super Duty	08-10	6	FMK1016	-	330mm	10	Auto-Ajustable
	V8 7.3L	Super Duty	99-03	6	FMK1008	N8126	330mm	10	Incluye Volante Sólido & Repuesto Hidráulico
LOBO									
	V6 4.2L		97-98		07129	N8096	290mm	10	Auto-Ajustable & CSC
RANGER									
	L4 2.3L		88-92		07132	N1754	225mm	23	Repuesto Hidráulico
	L4 2.3L		93-94	4	07093	N8093	225mm	23	Incluye Repuesto Hidráulico
	L4 2.3L		95-12	5	KFM06CSC	-	228mm	23	No - Autoajustable
	L4 2.5L		98-01	5	KFM06CSC	-	228mm	23	No - Autoajustable
	V6 2.9L		88-92		07132	N1754	225mm	23	Repuesto Hidráulico
	V6 3.0L		90-92		07132	N1754	225mm	23	Repuesto Hidráulico
	V6 3.0L		93-94		07099	N8096	225mm	23	Incluye Repuesto Hidráulico
	V6 3.0L		95-08	5	KFM06CSC	-	228mm	23	No - Autoajustable
	V6 4.0L		90-97		07096	N8096	228mm	23	Repuesto Hidráulico
	V6 4.0L		98-00		07139	N8096	257mm	23	Auto-Ajustable & Repuesto Hidráulico
	V6 4.0L		01-11		FMK1000	N8096	257mm	23	Auto-Ajustable & Repuesto Hidráulico

FORD MICROBUS

Modelo	Motor	Versión	Año	Vel.	Pro-Kit #	Collarín	Diámetro	Estrías	Nota
RANGER									
	V8 5.0L		89-91	4	FMK1030EXMX	BRG0213	280mm	10	Diseño EXEDY- Diafragma
	V8 5.8L		89-91	4	FMK1030EXMX	BRG0213	280mm	10	Diseño EXEDY- Diafragma
	V8 5.8L		91-97	4	FMK1031EX	N1714SA	280mm	10	

HONDA

Modelo	Motor	Versión	Año	Vel.	Pro-Kit #	Collarín	Diámetro	Estrías	Nota
ACCORD									
	L4 2.2L		90-97	6	08014	BRG817	225mm	24	
	L4 2.3L		98-02	6	HCK1000	BRG817	210mm	24	
	L4 2.4L		03-07	6	HCK1005	BRG500	225mm	24	
	L4 2.4L		08-11	6	HCK1009	BRG500	225mm	24	
	V6 3.0L		03-10	6	HCK1007	BRG500	238mm	24	
CITY									
	L4 1.5L		09-10	5	HCK1013EX	BRG820	200mm	20	
	L4 1.5L		11-19	5	HCK1010	BRG820	190mm	20	
CIVIC									
	L4 1.5L		90-91	5	08012	BRG427	210mm	20	
	L4 1.5L		92-97	5	08022	BRG820	210mm	20	
	L4 1.6L		90-91	5	08012	BRG427	210mm	20	
	L4 1.6L		92-00	5	08022	BRG820	210mm	20	
	L4 1.7L		01-05	5	KHC08	BRG820	210mm	20	
	L4 1.8L		06-16	5	HCK1002	BRG820	215mm	20	
	L4 2.0L		17-19	6	HCK1014	BRG500	230mm	24	
CIVIC SI									
	L4 2.0L		02-05	6	KHC09	BRG500	215mm	24	
	L4 2.0L		06-09	6	KHC10	BRG500	215mm	24	
	L4 2.0L		10-11	6	HCK1011	BRG500	215mm	24	
	L4 2.4L		12-15	6	HCK1015	BRG500	219mm	24	
CIVIC SIR									
	L4 1.6L		99-00	5	KHC05	BRG817	219mm	24	
CIVIC TYPE R									
	L4 2.0L	Turbo	17-18	6	08810	BRG500	240mm	24	Racing- Ultra Fiber
	L4 2.0L	Turbo	17-18	6	08957	BRG500	240mm	24	Racing- Ceramético
FIT									
	L4 1.5L		05-08	5	HCK1006	BRG820	190mm	20	
	L4 1.5L		2009	5	HCK1010	BRG820	190mm	20	
	L4 1.5L		10-14	5	HCK1013EX	BRG820	200mm	20	
	L4 1.5L		15-19	6	HCK1010	BRG820	190mm	20	

HONDA CAMIONETAS SUV, PICK UPS & VEHICULOS COMERCIALES

Modelo	Motor	Versión	Año	Vel.	Pro-Kit #	Collarín	Diámetro	Estrías	Nota
ELEMENT									
	L4 2.4L		03-09	5	HCK1004	BRG500	228mm	24	
HRV									
	L4 1.8L		15-19	6	HCK1015	BRG500	219mm	24	
HYUNDAI									
Modelo	Motor	Versión	Año	Vel.	Pro-Kit #	Collarín	Diámetro	Estrías	Nota
ACCENT									
	L4 1.6L		17-21	6	HYK1009EX	BRG0177	215mm	20	
ATTITUDE									
	L4 1.2L		15-19	5	MBK1023	BRG0227	190mm	19	
	L4 1.4L		06-11	5	HYK1000	BRG0109	215mm	20	
	L4 1.4L		12-13	5	HYK1009EX	BRG0177	215mm	20	
	L4 1.4L		2014	5	HYK1016EX	BRG0177	200mm	20	
	L4 1.6L		10-11	5	HYK1016EX	BRG0177	200mm	20	
ATOS									
	L4 1.0L		01-04	5	HYK1015EX	BRG0211	180mm	24	
	L4 1.1L		05-12	5	HYK1015EX	BRG0211	180mm	24	
ELANTRA									
	L4 1.8L		2015	5	KIK1004	BRG0177	236mm	20	
i10									
	L4 1.1L		12-14	5	HYK1015EX	BRG0211	180mm	24	
GRAND i10									
	L4 1.2L		15-19	5	HYK1014EX	BRG0211	190mm	24	
VERNA									
	L4 1.5L		04-06	5	05091	BRG0109	200mm	20	
	L4 1.6L		04-06	5	HYK1000	BRG0109	215mm	20	

HYUNDAI CAMIONETAS SUV, PICK UPS & VEHICULOS COMERCIALES

Modelo	Motor	Versión	Año	Vel.	Pro-Kit #	Collarín	Diámetro	Estrías	Nota
CRETA									
	L4 1.6L		17-19	6	Próximamente			-	
H-100									
	L4 2.4L		03-05	5	HYK1011EX	BRG0214	240mm	23	Volante Tipo Plano
	L4 2.4L	Van 1000	08-09	5	05041	BRG350	225mm	23	
	L4 2.4L		12-14	5	HYK1010EX	BRG0214	250mm	23	Volante Tipo Caja
	L4 2.5L	Diesel	06-12	5	HYK1011EX	BRG0214	240mm	23	Volante Tipo Plano
	L4 2.5L	Diesel	10-14	5	HYK1010EX	BRG0214	250mm	23	Volante Tipo Caja
STAREX									
	L4 2.4L		18-20	5	HYK1010EX	BRG0214	250mm	23	Volante Tipo Caja

KIA

Modelo	Motor	Versión	Año	Vel.	Pro-Kit #	Collarín	Diámetro	Estrías	Nota
RIO									
	L4 1.6L		2016	6	HYK1005	BRG0177	225mm	20	
	L4 1.6L		17-19	6	HYK1009	BRG0177	215mm	20	
SOUL									
	L4 1.6L		2016	6	Próximamente		240mm	20	
	L4 1.6L		17-19	6	HYK1009	BRG0177	215mm	20	

JEEP

Modelo	Motor	Versión	Año	Vel.	Pro-Kit #	Collarín	Diámetro	Estrías	Nota
COMPASS									
	L4 2.4L		07-14	5	CRK1017	-	230mm	17	Modular, Incluye CSC
LIBERTY									
	L4 2.4L		02-04	5	KJP01	-	228mm	19	
	L4 2.4L		2005	5	CRK1007	-	226mm	19	
	V6 3.7L		02-04		KJP02	-	263mm	10	Disco con Resortes
	V6 3.7L		05-06		CRK1006	-	265mm	10	Disco Rígido
PATRIOT									
	L4 2.4L		07-14	5	CRK1017	-	230mm	17	Modular, Incluye CSC
TJ									
	L4 2.5L		97-02		01040	N8074	225mm	14	
WRANGLER									
	L4 2.4L		03-04	6	KJP03	-	228mm	19	
	L4 2.4L		05-06	6	CRK1007	-	226mm	19	
	L4 2.5L	SE	87-92	6	01033	N8077	225mm	14	Incluye CSC
	L4 2.5L	SE	94-02	6	01040	N8074	225mm	14	
	V6 3.8L		07-11	6	CRK1016	-	263mm	10	
	L6 4.0L		89-92	6	01034	N8076	265mm	10	
	L6 4.0L		1993	6	01037	N8088	265mm	10	Incluye CSC
	L6 4.0L	Sahara	97-07	5	05065	N8074	265mm	10	Incluye CSC

MAZDA

Modelo	Motor	Versión	Año	Vel.	Pro-Kit #	Collarín	Diámetro	Estrías	Nota
MAZDA 2									
	L4 1.5L		12-15	5	MZK1010	BRG0200	200mm	20	
	L4 1.5L	R	16-	6	Próximamente	BRG0200			
MAZDA 3									
	L4 2.0L		06-13	5	MZK1003	BRG0146	225mm	22	
	L4 2.0L	SkyActiv	2014	6	MZK1012	BRG0215	230mm	23	Disco / 6 Resortes
	L4 2.0L		15-18	6	MZK1019EX	BRG0215	240mm	23	
	L4 2.3L		06-13	6	MZK1003	BRG0146	225mm	22	
	L4 2.3L	Speed	08-13	6	Próximamente	BRG0215			
	L4 2.5L		10-13	6	MZK1009	BRG0146	230mm	22	
	L4 2.5L		2014	6	MZK1013EX	BRG0215	230mm	22	Disco con Resortes
	L4 2.5L	Touring	15-18	6	Próximamente	BRG0215	240mm	23	
MAZDA 6									
	L4 2.3L		06-08	5	MZK1000	BRG452	215mm	22	
	L4 2.5L	I-Sport	09-13	6	MZK1008	BRG452	230mm	22	
	V6 3.0L		06-08	5	MZK1001	BRG452	240mm	23	
MX-5									
	L4 2.0L		06-10	6	MZK1006	BRG452	215mm	23	
	L4 2.0L		16-19	6	MZK1018EX	BRG0215	215mm	22	

MAZDA CAMIONETAS SUV, PICK UPS & VEHICULOS COMERCIALES

Modelo	Motor	Versión	Año	Vel.	Pro-Kit #	Collarín	Diámetro	Estrías	Nota
MAZDA 5									
	L4 2.3L		06-11	5	MZK1003	BRG0146	225mm	22	

MINI

Modelo	Motor	Versión	Año	Vel.	Pro-Kit #	Collarín	Diámetro	Estrías	Nota
MINI COOPER									
	L4 1.6L		02-04	5	BMK1000	-	200mm	18	
	L4 1.6L		2005	5	BMK1013	-	200mm	17	
	L4 1.6L		06-07	5	BMK1014	-	200mm	17	
	L4 1.6L	"S"	02-06	6	BMK1001	BRG0131	215mm	14	Para Volante DMF
	L4 1.6L	"S"	02-06	6	BMK1001FW	BRG0131	215mm	14	Conversión a Volante SÓLIDO

MITSUBISHI

Modelo	Motor	Versión	Año	Vel.	Pro-Kit #	Collarín	Diámetro	Estrías	Nota
ECLIPSE									
	L4 2.4L		00-05	5	MBK1000	BRG210	225mm	20	
	V6 3.8L	GT	06-08	6	MBK1015	-	240mm	23	Incluye CSC
LANCER									
	L4 2.0L		02-03	5	MBK1004	BRG0133	225mm	20	
	L4 2.0L		04-07	5	MBK1008	BRG210	225mm	20	
	L4 2.0L		08-16	5	MBK1011	BRG0162	225mm	20	Incluye CSC
	L4 2.0L	Evolution	2006	6	MBK1001	BRG601	240mm	23	
	L4 2.0L	Evolution	08-15	5	MBK1009	BRG605	240mm	23	
	L4 2.4L	Ralliart	05-06	5	MBK1007	BRG210	228mm	20	
	L4 2.4L	GTS	09-10	5	MBK1018	BRG0162	230mm	20	Incluye CSC
MIRAGE									
	L3 1.2L		15-19	5	MBK1023	BRG0227	190mm	19	

MITSUBISHI CAMIONETAS SUV, PICK UPS & VEHICULOS COMERCIALES

Modelo	Motor	Versión	Año	Vel.	Pro-Kit #	Collarín	Diámetro	Estrías	Nota
L200									
	L4 2.4L		08-19	5	MBK1021EX	BRG350	225mm	23	
	L4 2.5L	Diesel	08-19	5	MBK1020EX	BRG0202	250mm	23	

NISSAN

Modelo	Motor	Versión	Año	Vel.	Pro-Kit #	Collarín	Diámetro	Estrías	Nota
240 SX									
	L4 2.4L		91-98	6	06054	BRG810	225mm	24	
300 ZX									
	V6 3.0L		89-96	6	06045	BRG810	240mm	24	
350 Z									
	V6 3.5L		03-08	6	NSK1000FW	BRG0130	250mm	24	Inc. Volante Sólido
370 Z									
	V6 3.7L		09-16	6	NSK1024FW	BRG0163	250mm	24	Incluye Volante Sólido & CSC
	V6 3.7L		17-19	6	NSK1037	BRG0163	240mm	24	Incluye CSC
ALMERA									
	L4 1.8L		02-05	5	KNS02	BRG437	215mm	18	
APRIO									
	L4 1.6L		08-10	5	NSK1025EX	BRG0191	200mm	26	
ALTIMA									
	L4 2.4L		93-97	5	KNS04	BRG844	225mm	24	
	L4 2.4L		98-01	5	KNS06	BRG437	225mm	24	
	V6 3.5L	SE-R	05-06	6	NSK1002	BRG809	240mm	24	
LUCINO									
	L4 1.6L		99-00	5	06040EXMX	BRG433	190mm	18	
	L4 2.0L		96-00	5	KNS02	BRG437	215mm	18	
MARCH									
	L4 1.6L		12-19	5	NSK1027EX	BRG0210	215mm	26	Incluye CSC
MAXIMA									
	V6 3.0L		85-01	6	06044	BRG809	240mm	24	
	V6 3.5L		02-06	6	NSK1002	BRG809	240mm	24	
MICRA									
	L4 1.4L		05-07	5	NSK1028EX	BRG0210	190mm	26	Incluye CSC

NISSAN

Modelo	Motor	Versión	Año	Vel.	Pro-Kit #	Collarín	Diámetro	Estrías	Nota
NOTE									
	L4 1.6L		14-19	5	NSK1027EX	BRG0210	215mm	26	Incluye CSC
PLATINA									
	L4 1.6L		02-10	5	NSK1025EX	BRG0191	200mm	26	
SENTRA									
	L4 1.6L		96-00	5	06040EXMX	BRG433	190mm	18	
	L4 1.8L		01-06	5	KNS02	BRG437	215mm	18	
	L4 1.8L		13-19	6	NSK1009	BRG0166	225mm	21	Para DMF. Incluye CSC
	L4 1.8L		13-19	6	NSK1026FW	BRG0166	225mm	21	Incluye Volante Sólido
	L4 2.0L	GSS	96-01	5	KNS02	BRG437	215mm	18	
	L4 2.0L		07-12	6	NSK1009	BRG0166	225mm	21	Para DMF. Incluye CSC
	L4 2.0L		07-12	6	NSK1026FW	BRG0166	225mm	21	Conversión a Volante Sólido
SENTRA SE-R									
	L4 2.5L		02-06	6	NSK1003	BRG844	240mm	24	
	L4 2.5L		07-10	6	NSK1040EX	BRG0166	240mm	21	Incluye CSC
	L4 2.5L		11-12	6	NSK1031EX	BRG0210	240mm	21	Incluye CSC
SENTRA SE-R SPEC V									
	L4 2.5L		02-06	6	NSK1003	BRG844	240mm	24	
	L4 2.5L		07-10	6	NSK1040EX	BRG0166	240mm	21	Incluye CSC
SENTRA SR - SPORT ROAD									
	L4 1.6L	Turbo	17-21	6	NSK1026FW	BRG0166	225mm	21	Kit Conversión / Incluye Volante Sólido
	L4 2.5L		11-12	6	NSK1031EX	BRG0210	240mm	21	Incluye CSC
TIIDA									
	L4 1.6L		13-19	5	NSK1027EX	BRG0210	215mm	26	Incluye CSC
	L4 1.8L		07-19	6	NSK1009	BRG0166	225mm	21	Para DMF. Incluye CSC
	L4 1.8L		07-19	6	NSK1026FW	BRG0166	225mm	21	Kit Conversión / Incluye Volante Sólido
TSUBAME									
	L4 1.6L		93-05	5	06040EXMX	BRG433E	190mm	18	
	L4 1.6L		93-05	5	06040EXMX	BRG433E	190mm	18	
TSURU									
	L4 1.5L	TSURU I	84-87	4	06021	BRG218	184mm	18	
	L4 1.6L	TSURU II	88-91	4	06021	BRG218	184mm	18	
	L4 1.6L	TSURU II	88-91	5	06021	BRG218	184mm	18	
	L4 1.6L	TSURU III	92-17	5	06040EXMX	BRG433E	190mm	18	
	L4 2.0L	TSURU III	93-96	5	KNS02	BRG437	215mm	18	
VERSA									
	L4 1.6L		12-19	5	NSK1027EX	BRG0210	215mm	26	Incluye CSC

NISSAN CAMIONETAS SUV, PICK UPS & VEHICULOS COMERCIALES

Modelo	Motor	Versión	Año	Vel.	Pro-Kit #	Collarín	Diámetro	Estrías	Nota
FRONTIER									
	L4 2.4L		00-08	5	NSK1014HDEX	BRG0235	240mm	24	Reforzado
	L4 2.5L	NP300	16-19	6	NSK1033EX	BRG0130	240mm	24	
	L4 2.5L	NP300 Diesel	16-19	6	NSK1034EX	BRG0130	275mm	24	L-PEC (Auto-Ajustable)
	V6 3.3L		00-04	5	KNS10	BRG0130	250mm	24	
	V6 3.3L	Supercargada	2004	5	NSK1007	BRG0130	250mm	24	
	V6 4.0L		11-15	5	NSK1006	BRG0130	260mm	24	
ICHI VAN									
	L4 1.8L		88-94	5	06009	BRG0216	225mm	24	
	L4 2.4L		92-94	5	NSK1014HDEX	BRG0235	240mm	24	Reforzado
JUKE									
	L4 1.6L	Turbo	12-14	6	NSK1026FW	BRG0166	225mm	21	Conversión a Volante Sólido
PATHFINDER									
	V6 3.3L		2000	5	KNS10	BRG0130	250mm	24	
PICK UP / NP300									
	L4 1.8L	Pick Up	88-93	5	06009	BRG0216	225mm	24	
	L4 2.4L	720	83-93	5	NSK1014HDEX	BRG0235	240mm	24	Reforzado
	L4 2.4L	D21	94-08	5	NSK1014HDEX	BRG0235	240mm	24	Reforzado
	L4 2.4L	NP300	09-15	5	NSK1014HDEX	BRG0235	240mm	24	Reforzado
	L4 2.5L	NP300	16-19	6	NSK1033EX	BRG0235	240mm	24	
	L4 2.5L	NP300 Diesel (D22)	09-15	5	NSK1010EX	BRG437	250mm	24	
	L4 2.5L	NP300 Diesel	16-19	6	NSK1034EX	BRG0235	275mm	24	L-PEC (Auto-Ajustable)

NISSAN CAMIONETAS SUV, PICK UPS & VEHICULOS COMERCIALES

Modelo	Motor	Versión	Año	Vel.	Pro-Kit #	Collarín	Diámetro	Estrías	Nota
URVAN / NV350									
L4 2.4L			00-07	5	NSK1014HDEX	BRG0235	240mm	24	Reforzado
L4 2.5L			08-13	5	NSK1013EX	BRG0235	240mm	24	
L4 2.5L			14-16	5	NSK1032EX	BRG0235	240mm	24	
L4 2.5L			17->	5	NSK1039EX	BRG0235	240mm	24	
L4 2.5L	Diesel		14-19	5	NSK1035EX	BRG0235	275mm	24	L-PEC (Auto-Ajustable)
L4 3.0L	Diesel		08-13	5	NSK1012EX	BRG844	240mm	24	
XTERRA									
L4 2.4L			00-04	5	NSK1014HDEX	BRG0235	240mm	24	Reforzado
V6 3.3L			00-04	5	KNS10	BRG0130	250mm	24	
V6 3.3L	Supercargada		02-03	5	NSK1007	BRG0130	250mm	24	

PEUGEOT

Modelo	Motor	Versión	Año	Vel.	Pro-Kit #	Collarín	Diámetro	Estrías	Nota
206									
L4 1.4L		XS	99-09	5	PGK1002EX	BRG0219	180mm	18	
L4 1.6L			01-08	5	PGK1000EX	BRG0219	200mm	18	
207									
L4 1.4L			08-11	5	PGK1001EX	BRG0228	200mm	18	
L4 1.6L			08-11	5	PGK1001EX	BRG0228	200mm	18	

PEUGEOT CAMIONETAS SUV, PICK UPS & VEHICULOS COMERCIALES

Modelo	Motor	Versión	Año	Vel.	Pro-Kit #	Collarín	Diámetro	Estrías	Nota
GRAND RAID									
L4 1.6L			07-12	5	PGK1001EX	BRG0228	200mm	18	
PARTNER									
L4 1.6L			03-12	5	PGK1001EX	BRG0228	200mm	18	

PONTIAC

Modelo	Motor	Versión	Año	Vel.	Pro-Kit #	Collarín	Diámetro	Estrías	Nota
G3									
L4 1.6L			06-10	5	GMK1037	BRG0151	215mm	24	
G4									
L4 2.2L			05-09	5	GMK1010	BRG0143	225mm	14	Incluye CSC
G5									
L4 2.2L			05-09	5	GMK1010	BRG0143	225mm	14	Incluye CSC
G6									
L4 2.4L			06-08	5	GMK1010	BRG0143	225mm	14	Incluye CSC
GRAND AM									
L4 2.2L			02-04	5	GMK1000	N8133	225mm	14	Incluye CSC
L4 2.4L			00-01	5	KGM04	N8133	225mm	14	Incluye CSC
J2000									
L4 2.2L			95-00	5	04161	N8105	215mm	14	Incluye CSC
L4 2.2L			02-05	5	GMK1000	N8133	225mm	14	Incluye CSC
L4 2.3L			1995	5	04158	N8105	225mm	14	Incluye CSC
SOLSTICE									
L4 2.4L			06-09	5	04802	-	225mm	26	SET - Stage 1 Racing
SUNBIRD									
L4 2.2L			95-00	5	04161	N8105	215mm	14	Incluye CSC
L4 2.2L			02-05	5	GMK1000	N8133	225mm	14	Incluye CSC
L4 2.3L			1995	5	04158	N8105	225mm	14	Incluye CSC
SUNFIRE									
L4 2.2L			95-00	5	04161	N8105	215mm	14	Incluye CSC
L4 2.2L			02-05	5	GMK1000	N8133	225mm	14	Incluye CSC
L4 2.3L			1995	5	04158	N8105	225mm	14	Incluye CSC

RENAULT

Modelo	Motor	Versión	Año	Vel.	Pro-Kit #	Collarín	Diámetro	Estrías	Nota
CLIO									
L4 1.6L			02-10	5	NSK1025EXMX	BRG0191	200mm	26	
FLUENCE									
L4 2.0L			11-17	6	NSK1009	BRG0166	225mm	21	
					NSK1026FW				Kit Conversión / Incluye Volante Sólido

RENAULT

Modelo	Motor	Versión	Año	Vel.	Pro-Kit #	Collarín	Diámetro	Estrías	Nota
LOGAN									
L4 1.6L			15-16	5	RNK1000EX	BRG0191	200mm	26	
L4 1.6L			17-19	5	RNK1001EX	BRG0210	200mm	26	Incluye CSC

RENAULT CAMIONETAS SUV, PICK UPS & VEHICULOS COMERCIALES

Modelo	Motor	Versión	Año	Vel.	Pro-Kit #	Collarín	Diámetro	Estrías	Nota
KANGOO									
L4 1.6L			02-13	5	NSK1025EXMX	BRG0191	200mm	26	
SANDERO									
L4 1.6L			10-15	5	RNK1000EX	BRG0191	200mm	26	
L4 1.6L			16-19	5	RNK1001EX	BRG0210	200mm	26	Incluye CSC
L4 2.0L		RS	16-17	5	Próximamente				
STEPWAY									
L4 1.6L			10-15	5	RNK1000EX	BRG0191	200mm	26	
L4 1.6L			16-19	5	RNK1001EX	BRG0210	200mm	26	Incluye CSC

SEAT

Modelo	Motor	Versión	Año	Vel.	Pro-Kit #	Collarín	Diámetro	Estrías	Nota
ALTEA									
L4 2.0L		ALTEA	05-06	5	VWK1004	-	228mm	28	
CORDOBA									
L4 1.6L			01-02	5	17038	N3758	210mm	28	
L4 1.6L			04-09	5	VWK1010EX	BRG0220	200mm	28	
L4 2.0L			03-	5	Próximamente		216mm	28	
IBIZA									
L4 1.2L		Turbo	13-17	5	AUK1004EX	BRG0220	219mm	28	Para Volante Plano
L4 1.6L			01-02	5	17038	N3758	210mm	28	
L4 1.6L			04-09	5	VWK1010EX	BRG0220	200mm	28	
L4 1.6L		Style	13-20	5	AUK1004EX	BRG0220	219mm	28	Para Volante Plano
LEON									
L4 1.8L			01-06	5	KVV05	-	215mm	28	
L4 1.8L		Turbo	01-06	6	VWK1002	-	240mm	23	Incluye CSC
L4 1.8L		Turbo	08-	6	Próximamente		-	-	
L4 1.8L		Cupra Turbo	03-06	6	VWK1002	-	240mm	23	Incluye CSC
L4 2.0L			06-09	5	VWK1004	-	228mm	28	
L4 2.0L		FR Turbo	07-13	6	VWK1005	-	240mm	23	Incluye CSC
L4 2.0L		Cupra Turbo	06-	6	VWK1005	-	240mm	23	Incluye CSC
TOLEDO									
L4 1.2L		TSI	13-17	6	AUK1004EX	BRG0220	219mm	28	Para Volante Plano
L4 1.6L			13-19	5	AUK1004EX	BRG0220	219mm	28	Para Volante Plano
L4 1.8L			01-05	5	KVV05	-	215mm	28	
L4 1.8L		Turbo	01-04	6	VWK1002	-	240mm	23	Incluye CSC
L4 2.0L			2006	5	VWK1004	-	228mm	28	

SUBARU

Modelo	Motor	Versión	Año	Vel.	Pro-Kit #	Collarín	Diámetro	Estrías	Nota
IMPREZA									
H4 2.0i			08-17	5	KSB04	BRG833	225mm	24	
H4 2.5i			08-17	5	KSB04	BRG833	225mm	24	
H4 2.0i		WRX Turbo	15-17	6	FJK1001	BRG0147	230mm	24	
H4 2.0i		WRX Turbo	15-17	6	FJK1001FW	BRG0147	230mm	24	Incluye Volante Sólido
H4 2.5i		WRX Turbo	08-14	5	FJK1001	BRG0147	230mm	24	
H4 2.5i		WRX Turbo	08-14	5	FJK1001FW	BRG0147	230mm	24	Incluye Volante Sólido
H4 2.5i		WRX STI Turbo	07-17	6	FJK1000	BRG601	240mm	24	Tipo Jalón

SUZUKI

Modelo	Motor	Versión	Año	Vel.	Pro-Kit #	Collarín	Diámetro	Estrías	Nota
AERIO									
L4 2.3L			06-07	5	SZK1001	BRG438	200mm	20	
CIAZ									
L4 1.4L			15-19	5	SZK1011EX	BRG0240	190mm	10	Incluye CSC
IGNIS									
L4 1.2L			17-20	5	SZK1013EX	BRG0236	190mm	18	

SUZUKI

Modelo	Motor	Versión	Año	Vel.	Pro-Kit #	Collarín	Diámetro	Estrías	Nota
SWIFT									
	L3 1.0L	Turbo	17-20	5	Próximamente	BRG0234			Boosterjet
	L4 1.2L		18-20	5	SZK1013EX	BRG0236	190mm	18	
	L4 1.4L		12-17	5	SZK1005EX	BRG0212	190mm	18	Para Volante Tipo Caja
	L4 1.4L	Sport	18-21	6	SZK1014EX	BRG0234	215mm	20	
	L4 1.5L		07-11	5	SZK1004EX	BRG454	190mm	18	
	L4 1.6L	Sport	13-17	6	SZK1010EX	BRG0234	200mm	20	Incluye CSC

SUZUKI CAMIONETAS SUV, PICK UPS & VEHICULOS COMERCIALES

Modelo	Motor	Versión	Año	Vel.	Pro-Kit #	Collarín	Diámetro	Estrías	Nota
S-CROSS									
	L4 1.6L		14-18	5	SZK1010EX	BRG0234	200mm	20	Incluye CSC
SX4									
	L4 2.0L		08-09	5	SZK1003	BRG0234	215mm	20	Incluye CSC
	L4 2.0L		10-14	6	SZK1007EX	BRG0234	215mm	20	Incluye CSC
VITARA									
	L4 1.4L	Turbo	17-19	6	SZK1012EX	BRG0234	215mm	20	Incluye CSC
	L4 1.6L		16-19	5	SZK1010EX	BRG0234	200mm	20	Incluye CSC

TOYOTA

Modelo	Motor	Versión	Año	Vel.	Pro-Kit #	Collarín	Diámetro	Estrías	Nota
COROLLA									
	L4 1.8L	C	03-08	5	TYK1501	BRG840	213mm	21	
	L4 1.8L	C	09-13	5	TYK1518	BRG840	212mm	21	
	L4 1.8L	S	14-19	6	TYK1522	BRG0222	210mm	21	Incluye CSC
	L4 1.8L	Sport	05-08	5	TYK1501	BRG840	213mm	21	
	L4 2.4L	XRS	09-13	5	TYK1506	BRG451	236mm	21	
MATRIX									
	L4 1.8L		09-10	5	TYK1518	BRG840	212mm	21	
	L4 1.8L	XR	03-08	5	TYK1501	BRG840	213mm	21	
	L4 2.4L	XR	2010	5	TYK1506	BRG451	236mm	21	
	L4 1.8L	XRS	03-08	6	KTY14	BRG840	210mm	21	
MR2 SPYDER									
	L4 1.8L		05-06	6	KTY03	BRG840	210mm	21	
YARIS									
	L4 1.3L		04-05	5	TYK1520EX	BRG371	200mm	21	
	L4 1.5L		06-16	5	TYK1504	BRG0124	210mm	21	
	L4 1.5L	"R"	2016	6	Próximamente	-	-	-	
	L4 1.5L	RLE & RXLE	17-20	6	Próximamente	-	-	-	
	L4 1.5L	"S"	18-21	5	Próximamente	-	-	-	

TOYOTA CAMIONETAS SUV, PICK UPS & VEHICULOS COMERCIALES

Modelo	Motor	Versión	Año	Vel.	Pro-Kit #	Collarín	Diámetro	Estrías	Nota
AVANZA									
	L4 1.5L		07-19	5	TYK1517EX	BRG0203EX	200mm	20	
HIACE									
	L4 2.7L		06-19	5	16090	BRG444	250mm	21	
	L4 2.8L	Diesel	20->	6	TYK1523EX	BRG0238	275mm	21	
HILUX									
	L4 2.7L		06-15	5	16090	BRG444	250mm	21	
	L4 2.7L		16-20	5	TYK1524EX	BRG0237	250mm	21	
	L4 2.8L	Diesel	18->	6	TYK1523EX	BRG0238	275mm	21	
PICK UP (22R)									
	L4 2.4L		85-94	5	16058	BRG445	225mm	21	
RUSH									
	L4 1.5L		2009	5	TYK1521EX	BRG426	200mm	20	

VOLKSWAGEN

Modelo	Motor	Versión	Año	Vel.	Pro-Kit #	Collarín	Diámetro	Estrías	Nota
BEETLE									
	L4 1.8L	Turbo S	02-05	6	VWK1002	-	240mm	23	Incluye CSC
	L4 2.0L		98-05	5	KVV05	-	215mm	28	
	L4 2.0L	Turbo	12->	5	Próximamente	-	240mm	23	

VOLKSWAGEN

Modelo	Motor	Versión	Año	Vel.	Pro-Kit #	Collarín	Diámetro	Estrías	Nota
BEETLE									
	L5 2.5L		06-11	5	VWK1004	-	228mm	28	
	V6 3.2L	Super	02-04	6	VWK1006	-	240mm	23	Incluye CSC
BORA									
	L4 1.9L		08-10	5	VWK1004	-	228mm	28	
	L4 2.0L	GLI	06-10	5	VWK1005	-	240mm	23	Incluye CSC
	L4 2.0L	Turbo	06-10	5	VWK1005	-	240mm	23	Incluye CSC
	L5 2.5L		06-10	5	VWK1004	-	228mm	28	
CABRIOLET									
	L4 1.8L		84-92	5	17012	N3758	210mm	24	
DERBY									
	L4 1.8L		94-09	5	KVV01	-	210mm	24	
	L4 2.0L		01-04	5	KVV05	-	215mm	28	
	L4 2.0L		02-05	5	17038	N3758	210mm	28	
GOL									
	L4 1.6L		09-19	5	VWK1010EX	BRG0220	200mm	28	
GOLF									
	L4 1.8L	A2	88-92	4	17012	N3758	210mm	24	
	L4 1.8L	A2	88-92	5	17012	N3758	210mm	24	
	L4 1.8L	A3	93-99	4	17012	N3758	210mm	24	
	L4 1.8L	A3	93-99	5	17012	N3758	210mm	24	
	L4 2.0L	A3	93-99	5	KVV01	-	210mm	24	
	L4 2.0L	A3 Cabrio	96-99	5	KVV05	-	215mm	28	
	L4 2.0L	A3 GTI	92-96	5	17027	N3758	210mm	28	
	V6 2.8L	A3 VR6	95-99	5	17036	N8031	228mm	28	
	L4 2.0L	A4 & Cabrio	00-07	5	KVV05	-	215mm	28	
	L4 2.0L	A4 GTI	00-03	5	17038	N3758	210mm	28	
	V6 2.8L	A4 VR6	99-02	5	17036	N8031	228mm	28	
	V6 3.2L	A4 R32	2004	6	VWK1006	-	240mm	23	Incluye CSC
GTI									
	L4 2.0L	GTI Turbo	07-09	6	VWK1005	-	240mm	23	Incluye CSC
JETTA									
	L4 1.8L	A2	88-92	5	17012	N3758	210mm	24	
	L4 1.8L	A3	93-99	5	KVV01	-	210mm	24	
	L4 2.0L	A3	93-99	5	17038	N3758	210mm	28	
	V6 2.8L	A3	95-99	5	17036	N8031	228mm	28	
	L4 2.0L	A4	00-10	5	KVV05	-	215mm	28	
	L4 2.0L	Clásico	11-15	5	KVV05	-	215mm	28	
	L4 2.0L	GLI Turbo	12-14	6	Próximamente	-	240mm	23	Incluye CSC
	V6 2.8L	A4 VR6	99-02	5	17036	N8031	228mm	28	
	V6 2.8L	A4 VR6	02-04	5	VWK1002	-	240mm	23	Incluye CSC
LUPO									
	L4 1.6L		05-09	5	VWK1010EX	BRG0220	200mm	28	
PASSAT									
	L4 1.8L	Turbo	99-05	5	VWK1001	-	228mm	23	
	L4 2.0L		93-96	5	17034	N8031	228mm	28	
	L4 2.0L	Turbo CC	06-07	6	VWK1005	-	240mm	23	Incluye CSC
	V6 2.8L	VR6	93-97	5	17036	N8031	228mm	28	
	V6 2.8L		98-05	5	AUK1001	N8022	240mm	23	
	W8 4.0L	Motion	03-05	6	VWK1007	-	240mm	23	
POINTER									
	L4 1.8L	Sedan & Wagon	97-09	5	VWK1008EX	BRG0206	210mm	24	
	L4 2.0L	GTI	00-03	5	VWK1008EX	BRG0206	210mm	24	
POLO									
	L4 1.2L	TSI	13-14	6	AUK1004EX	BRG0220	219mm	28	Para Volante Plano
	L4 1.6L		03-07	5	VWK1010EX	BRG0220	200mm	28	
	L4 1.6L		15-20	5	AUK1004EX	BRG0220	219mm	28	Para Volante Plano
VENTO									
	L4 1.6L		14-19	5	VWK1011EX	BRG0220	200mm	28	

VOLKSWAGEN CAMIONETAS SUV, PICK UPS & VEHICULOS COMERCIALES

Modelo	Motor	Versión	Año	Vel.	Pro-Kit #	Collarín	Diámetro	Estrías	Nota
AMAROK									
	L4 2.0L	Turbo	13-14	6	VWK1009EX	BRG0216	240mm	26	Incluye CSC
	L4 2.0L	Turbo Diesel	11-20	6	VWK1009EX	BRG0216	240mm	26	Incluye CSC

VOLKSWAGEN CAMIONETAS SUV, PICK UPS & VEHICULOS COMERCIALES

Modelo	Motor	Versión	Año	Vel.	Pro-Kit #	Collarín	Diámetro	Estrías	Nota
CADDY									
	L4 1.2L		14-16	5	AUK1004EX	BRG0220	219mm	28	Para Volante Plano
	L4 1.6L		17-20	5	AUK1004EX	BRG0220	219mm	28	Para Volante Plano
CROSSFOX									
	L4 1.6L		06-15	5	VWK1010EX	BRG0220	200mm	28	
SAVEIRO									
	L4 1.6L		10-19	5	VWK1010EX	BRG0220	200mm	28	
SPORT VAN									
	L4 1.6L		07-10	5	VWK1010EX	BRG0220	200mm	28	
VAN									
	L4 1.8L		03-09	5	KVW05	-	215mm	28	



**CAMIONES
LIGEROS**

FOTON PICK UP

Modelo	Motor	Versión	Año	Vel.	Pro-Kit #	Collarín	Diámetro	Estrías	Nota
DFSK / K01 K01H & K02									
	L4 1.1L		15-19	5	Próximamente		190mm	18	-
	L4 1.3L		15-19	5	FTK1004EX	BRG0192	190mm	18	-

FOTON CAMIONES LIGEROS (DIESEL)

Modelo	Motor	Versión	Año	Vel.	Pro-Kit #	Collarín	Diámetro	Estrías	Nota
AUMARK 2000									
	L4 2.8L	80Kw	08-19	5	FTK1000EX	BRG0233	310mm	10	-
AUMARK 3000									
	L4 2.8L	90Kw	08-19	5	FTK1001EX	BRG0233	310mm	10	-
AUMARK 4000									
	L4 3.8L		08-19	6	NVK0001EX	BRG0229	325mm	10	-
AUMARK 5000									
	L4 3.8L		08-19	6	FTK1005EX	BRG0233	325mm	10	-
AUMARK 6000									
	L4 3.8L		08-19	6	FTK1002EX	BRG0233	350mm	10	-
AUMARK 7000									
	L4 3.8L		08-19	6	FTK1003EX	BRG0232	380mm	10	-

FREIGHTLINER CAMIONES LIGEROS (DIESEL)

Modelo	Motor	Versión	Año	Vel.	Pro-Kit #	Collarín	Diámetro	Estrías	Nota
FL 360- 715									
	L4 3.0L	4P10	20->	5	MFK1016EX	BRG0224	300mm	14	Incluye CSC
FL 360- 715									
	L4 4.9L	4M50	07-19	5	MFK1015EX	BRG0224	325mm	14	Incluye CSC
FL 360- 1217									
	L4 3.9L		17-19	6	Próximamente		362mm	-	-
FL 360- 2528									
	L6 6.4L		17-19	6	Próximamente		395mm	-	-

HINO CAMIONES LIGEROS - SERIE 300 CLASE 2 & 3 (DIESEL)

Modelo	Motor	Versión	Año	Vel.	Pro-Kit #	Collarín	Diámetro	Estrías	Nota
414									
	L4 4.0L		09-11	5	TYK1519EX	BRG0218	300mm	14	-
514									
	L4 4.0L		12-19	5	TYK1519EX	BRG0218	300mm	14	-
614									
	L4 4.0L		09-11	5	TYK1519EX	BRG0218	300mm	14	-
616									
	L4 4.0L		08-19	5	HNK1001	BRG903	325mm	14	-
716									
	L4 4.0L		2008	6	HNK1001	BRG903	325mm	14	-
	L4 4.0L		09-19	6	HNK1002	BRG0217	325mm	14	-
816									
	L4 4.0L		2008	6	HNK1001	BRG903	325mm	14	-
	L4 4.0L		09-19	6	HNK1002	BRG0217	325mm	14	-

HINO CAMIONES LIGEROS - SERIE 500 CLASE 6 & 8 (DIESEL)

Modelo	Motor	Versión	Año	Vel.	Pro-Kit #	Collarín	Diámetro	Estrías	Nota
1018									
	L4 4.7L		09-19	6	HNK1005	BRG0229	350mm	10	-
1524									
	L6 7.6L		09-19	6	HNK1006EX HNK1007EX	BRG0230	380mm	10	Disco Ceramético Versión Orgánico
1724									
	L6 7.6L		09-19	6	HNK1006EX HNK1007EX	BRG0230	380mm	10	Disco Ceramético Versión Orgánico
1727									
	L6 7.6L		09-19	6	HNK1006EX HNK1007EX	BRG0230	380mm	10	Disco Ceramético Versión Orgánico
2627									
	L6 7.7L		09-19	9	Próximamente		380mm	-	-

HINO CAMIONES LIGEROS - SERIE 500 BUS (DIESEL)

Modelo	Motor	Versión	Año	Vel.	Pro-Kit #	Collarín	Diámetro	Estrías	Nota
BF918K									
	L4 5.1L		17-19	6	HNK1005	BRG0229	350mm	10	-
BR1425									
	L6 7.6L		17-19	6	Próximamente		380mm	-	-
BF1524M									
	L6 7.6L		17-19	6	Próximamente		380mm	-	-

HYUNDAI CAMIONES LIGEROS (DIESEL)

Modelo	Motor	Versión	Año	Vel.	Pro-Kit #	Collarín	Diámetro	Estrías	Nota
H200									
	L4 2.5L	D4CB	2017->	5	Próximamente	BRG440	-	-	-
H300									
	L4 3.9L	D4GA14	2017->	5	Próximamente	BRG493	-	-	-

INTERNATIONAL CAMIONES LIGEROS CLASE 3, 4, 5 & 6 (DIESEL)

Modelo	Motor	Versión	Año	Vel.	Pro-Kit #	Collarín	Diámetro	Estrías	Nota
CITYStar 3									
	L4 2.8L	HPCR	13-14	5	NVK1001EX	BRG0243	275mm	24	
	L4 2.8L	4DA1	15-19	5	FT803203U	-	310mm	10	Set (Plato & Disco)
	L4 2.8L	ISF	15-19	5	FT804203U	-	310mm	10	Set (Plato & Disco)
CITYStar 4									
	L4 3.8L	ISF	13-19	6	NVK0001EX	BRG0229	325mm	10	Kit Incluye Collarín / Balero C/ Porta-Collarín / Por Separado
						BRG0233			
CITYStar 5									
	L4 3.8L	ISF	13-19	6	NVK0001EX	BRG0229	325mm	10	Kit Incluye Collarín / Balero C/ Porta-Collarín / Por Separado
						BRG0233			
CITYStar 6									
	L4 4.5L	ISF	15-19	6	Próximamente	-	395mm	-	-

ISUZU CAMIONES LIGEROS (DIESEL)

Modelo	Motor	Versión	Año	Vel.	Pro-Kit #	Collarín	Diámetro	Estrías	Nota
ELF 100									
	L4 3.0L		09-19	5	ISK1014EX	-	250mm	24	Venta solo en Kit
ELF 200									
	L4 3.0L		08-19	5	ISK1010EX	BRG0199	300mm	14	-
ELF 300									
	L4 3.0L		08-19	5	ISK1010EX	BRG0199	300mm	14	-
ELF 400									
	L4 5.2L		07-19	6	ISK1011EX ISK1012EX	BRG0201	325mm	14	Disco Ceramético Versión Orgánico
ELF 450									
	L4 5.2L		07-19	6	ISK1011EX ISK1012EX	BRG0201	325mm	14	Disco Ceramético Versión Orgánico
ELF 500									
	L4 5.2L		07-19	6	ISK1011EX ISK1012EX	BRG0201	325mm	14	Disco Ceramético Versión Orgánico
ELF 600									
	L4 5.2L		07-19	6	ISK1011EX ISK1012EX	BRG0201	325mm	14	Disco Ceramético Versión Orgánico
ELF 600 BUS									
	L4 5.2L		07-19	6	ISK1011EX ISK1012EX	BRG0201	325mm	14	Disco Ceramético Versión Orgánico
FORWARD 800									
	L4 5.2L		10-13	6	ISK1013EX	BRG0201	350mm	10	-
FORWARD 1100									
	L4 5.2L		14-16	6	ISK1015EX	BRG0201	350mm	10	-
FORWARD 1400									
	L4 5.2L		17-18	6	Próximamente	-	380mm	10	-

NISSAN CAMIONES LIGEROS (DIESEL)

Modelo	Motor	Versión	Año	Vel.	Pro-Kit #	Collarín	Diámetro	Estrías	Nota
CABSTAR									
L4 2.5L		Diesel	08-18	6	NSK1029EX	BRG0130	250mm	24	
L4 2.5L		Diesel	08-18	6	NSK1041EX	BRG0130	250mm	24	Reforzado

STERLING CAMIONES LIGEROS (DIESEL)

Modelo	Motor	Versión	Año	Vel.	Pro-Kit #	Collarín	Diámetro	Estrías	Nota
FL 360									
L4 4.9L			07-10	5	MFK1015EX	BRG0224	325mm	14	Incluye CSC



**VEHÍCULOS
IMPORTADOS**

VEHÍCULOS IMPORTADOS



ACURA

Modelo	Motor	Versión	Año	Vel.	Pro-Kit #	Collarín	Diámetro	Estrías	Nota
CL									
	L4 2.2L		1997	5	08014	BRG817	225mm	24	
	L4 2.3L		98-99	5	08014	BRG817	225mm	24	
RSX									
	L4 2.0L		02-06	6	KHC10	BRG500	215mm	24	

CHEVROLET

Modelo	Motor	Versión	Año	Vel.	Pro-Kit #	Collarín	Diámetro	Estrías	Nota
Cavalier									
	V6 2.8L		85-86	4	04077	N1725SA	225mm	14	
Geo Metro									
	L4 1.0L		89-97	5	04124	BRG454	170mm	18	
	L4 1.3L		92-00	5	04100	BRG454	190mm	18	

CHRYSLER

Modelo	Motor	Versión	Año	Vel.	Pro-Kit #	Collarín	Diámetro	Estrías	Nota
Colt									
	L4 2.0L		85-91	5	MBK1000	BRG210	225mm	20	
	L4 1.6L	Turbo	89-90	5	MBK1000	BRG210	225mm	20	
Stratus									
	L4 2.4L		01-05	5	MBK1000	BRG210	225mm	20	
	V6 3.0L	SE & RT	01-05	5	KMB03	BRG601	230mm	23	

FORD

Modelo	Motor	Versión	Año	Vel.	Pro-Kit #	Collarín	Diámetro	Estrías	Nota
Ranger									
	L4 2.3L		93-94	5	07093	N8096	225mm	23	

HONDA

Modelo	Motor	Versión	Año	Vel.	Pro-Kit #	Collarín	Diámetro	Estrías	Nota
Civic Hybrid									
	L4 1.3L		06-		HCK1008	BRG820	219mm	20	
Prelude									
	L4 2.0L		88-89		08013	BRG817			

HYUNDAI

Modelo	Motor	Versión	Año	Vel.	Pro-Kit #	Collarín	Diámetro	Estrías	Nota
Santa Fe									
	L4 2.4L		01-04		KHY01	BRG0104	225mm	20	
	L4 2.4L		05-06		HYK1002	BRG0104	225mm	20	
	L4 2.4L		05-06		HYK1002FW	BRG0104	225mm	20	
Sonata									
	L4 2.4L		02-04		HYK1003	-	225mm	20	
	L4 2.4L		99-01		05100	BRG0104	225mm	20	
	V6 2.5L		99-01		05100	BRG0104	225mm	20	
	L4 2.7L		02-03		HYK1003	-	225mm	20	
Tiburon									
	L4 2.7L		03-08		HYK1003	-	225mm	20	

ISUZU

Modelo	Motor	Versión	Año	Vel.	Pro-Kit #	Collarín	Diámetro	Estrías	Nota
Rodeo									
	L4 2.2L		98-03	5	ISK1002	BRG0149	240mm	24	
	V6 3.1L		91-92	5	04130	-	232mm	14	
	V6 3.2L		92-93	5	KIS05	N8106	240mm	24	
	V6 3.2L		94-04	5	KIS01	BRG603	260mm	24	

KIA

Modelo	Motor	Versión	Año	Vel.	Pro-Kit #	Collarín	Diámetro	Estrías	Nota
Río									
	L4 1.5L		01-02		KKI02	BRG453	200mm	20	

VEHÍCULOS IMPORTADOS



KIA

Modelo	Motor	Versión	Año	Vel.	Pro-Kit #	Collarín	Diámetro	Estrías	Nota
Río									
	L4 1.6L		03-05		KKI02	BRG453	200mm	20	
Shephia									
	L4 1.8L		95-01		KKI01	BRG091	225mm	22	
Spectra									
	L4 1.8L		00-04		KKI01	BRG091	225mm	22	
	L4 2.0L		00-04		KKI01	BRG091	225mm	22	
Sportage									
	L4 2.0L		95-00		KKI01	BRG091	225mm	22	

MAZDA

Modelo	Motor	Versión	Año	Vel.	Pro-Kit #	Collarín	Diámetro	Estrías	Nota
626									
	L4 2.0L		93-02	5	07094	-	225mm	22	
MX-6									
	L4 2.0L		93-97	5	07094	-	225mm	22	

MITSUBISHI

Modelo	Motor	Versión	Año	Vel.	Pro-Kit #	Collarín	Diámetro	Estrías	Nota
Eclipse									
	L4 2.0L		90-94	5	05051	BRG210	215mm	20	
	L4 2.4L		00-05	5	MBK1000	BRG210	225mm	20	
	L4 2.4L		06-12	5	MBK1010	BRG210	230mm	20	
	V6 3.0L	GT	00-05	5	KMB02	BRG601			
Lancer									
	L4 2.0L		02-03	5	MBK1004	BRG0133	225mm	23	

MITSUBISHI CAMIÓN LIGERO (DIESEL)

Modelo	Motor	Versión	Año	Vel.	Pro-Kit #	Collarín	Diámetro	Estrías	Nota
Fuso Fighter									
	L6 6.6L	6D14	85-92	5	MFK1010	BRG0136	235mm	14	

NISSAN

Modelo	Motor	Versión	Año	Vel.	Pro-Kit #	Collarín	Diámetro	Estrías	Nota
240SX									
	L4 2.4L		91-98	5	06054	BRG810	225mm	24	
D21									
	V6 3.0L		86-94	5	06042	BRG016	250mm	24	
Pathfinder									
	V6 3.0L		87-95	5	06042	BRG016	250mm	24E	
Pick Up									
	V6 3.0L		95-96	5	06042	BRG016	250mm	24	

SATURN

Modelo	Motor	Versión	Año	Vel.	Pro-Kit #	Collarín	Diámetro	Estrías	Nota
Ion									
	L4 2.2L		03-07		GMK1017	BRG0154	228mm	14	

SUZUKI

Modelo	Motor	Versión	Año	Vel.	Pro-Kit #	Collarín	Diámetro	Estrías	Nota
Samurai									
	L4 1.3L		86-95		04104	BRG438	190mm	20	

TOYOTA

Modelo	Motor	Versión	Año	Vel.	Pro-Kit #	Collarín	Diámetro	Estrías	Nota
Camry									
	L4 2.0L		88-91	5	16082	BRG451	236mm	21	
	L4 2.0L		91-05	5	16073	BRG442	225mm	20	
	V6 2.5L		88-91		16082	BRG451	236mm	21	
	V6 3.0L		92-01		16062	BRG451	236mm	21	

VEHÍCULOS IMPORTADOS



TOYOTA

Modelo	Motor	Versión	Año	Vel.	Pro-Kit #	Collarín	Diámetro	Estrías	Nota
Celica									
	L4 2.0L	Turbo	88-89		16082	BRG451	236mm	21	
Corolla									
	L4 1.6L		87-88		16082	BRG451	236mm	21	
FJ Cruise									
	V6 4.0L		07-14	6	TYK1503	BRG0164	275mm	21	
Hilux 22R									
	L4 2.4L		91-94	5	16058	BRG445	225mm	21	
MR2									
	L4 2.2L		91-95	5	16073	BRG442	225mm	20	
	L4 2.0L	Turbo	91-95		16062	BRG451	236mm	21	
Pick Up 22R									
	L4 2.4L		85-94	5	16058	BRG445	225mm	21	
	V6 3.0L		90-95	5	16059	BRG445	236mm	21	
Tacoma									
	L4 2.4L	2WD	95-04		KTY13	BRG444	236mm	21	
	V6 3.4L		2005	5	16087	BRG902	250mm	21	
	V6 4.0L		05-15	6	TYK1503	BRG0164	275mm	21	
Tundra									
	V6 4.0L		05-	6	TYK1503	BRG0164	275mm	21	



**COLLARINES
& CSC**

COLLARINES & CSC



# Item	Referencia	Marca(s)	A	B	Aplicación
BRG010	5-31321-003-3 9-00095-035-0 9-00095-040-0 9-00095-040-1 9402-4052	ISUZU			ISUZU Amigo L4 2.3L 89-93 ISUZU Pickup L4 1.8L 81-94 ISUZU Pickup L4 19.L 81-86 ISUZU Pickup L4 2.0L 81-94 ISUZU Pickup L4 2.2L 81-94 ISUZU Pickup L4 2.0L 81-95
BRG0104	41421-28020	HYUNDAI			HYUNDAI Santa Fe L4 2.4L 01-04 HYUNDAI Santa Fe L4 2.4L 05-06 HYUNDAI Santa Fe L4 2.4L 05-06
BRG0107	2S61-7A564-CA 2S61-7A564-CB 8V21-7A564-AB 8V21-7A564-AC 8V21-7A564-AD	FORD			FORD Focus LX & SE L4 2.0L SOHC (110HP) 2000 5 Vel.
BRG0108	619103	FORD			FORD FOCUS L4 2.0L 99-04 5 Vel. FOCUS ZX3 L4 2.0L 00-05 5 Vel.
BRG0109	614126	DODGE / HYUNDAI			DODGE Verna L4 1.5L 04-06 5 Vel. DODGE Verna L4 1.6L 04-06 5 Vel. DODGE Attitude L4 1.4L 06-11 5 Vel.
BRG0124	6914152	TOYOTA			TOYOTA Yaris L4 1.5L 06-11 5 Vel.
BRG0127	23265-65D00	CHEVROLET			CHEVROLET Tracker L4 1.6L 89-20 CHEVROLET Tracker L4 2.0L 00-03
BRG0130	30502-69F10	NISSAN			NISSAN Frontier V6 3.3L 00-04 NISSAN Pathfinder V6 3.3L 2000 NISSAN Xterra V6 3.3L 00-04 NISSAN Frontier SUPERCARGADA V6 3.3L 2004 NISSAN Xterra SUPERCARGADA V6 3.3L 02-03 NISSAN 350 Z V6 3.5L 24V 287HP 03-08 6 Vel. NISSAN Urvan L4 2.5L 08-13 5 Vel. NISSAN Frontier SV V6 4.0L 2011 5 Vel. NISSAN Cabstar L4 2.5L TDI 6 Vel. 08-19

COLLARINES & CSC



# Item	Referencia	Marca(s)	A	B	Aplicación
BRG0131	21511044099	MINI			MINI Cooper S L4 1.6L 170HP 02-06 6 Vel.
BRG0133	-	MITSUBISHI			MITSUBISHI Lancer L4 2.0L 02-03 5 Vel.
BRG0136	Camión Importado	MITSUBISHI			MITSUBISHI Fuso Fighter L6 6.6L 6D14 85-92 5 Vel.
BRG0143	12582666	CHEVROLET			CHEVROLET HHR L4 2.4L DOHC 06-09 PONTIAC G4 & G5 L4 2.2L DOHC 05-09 PONTIAC G4 & G5 L4 2.4L DOHC 06-08
BRG0146	-	MAZDA			MAZDA 3 L4 2.0L 06-13 5 Vel. MAZDA 3 L4 2.3L 06-13 6 Vel. MAZDA 5 L4 2.3L Sport 06-10 5 Vel. MAZDA 3 S L4 2.5L 10-11 6 Vel.
BRG0147	30502-AA120	SUBARU			SUBARU Impreza WRX Turbo H4 2.5B 08-16 5 Vel. SUBARU Impreza SE H4 2.5B 08-16 5 Vel.
BRG0149	8-97316-591-0	ISUZU			ISUZU Rodeo L4 2.2L 98-03
BRG0151	614171	PONTIAC			CHEVROLET Aveo L4 1.6L 08-15 5 Vel. PONTIAC G3 L4 1.6L DOHC 06-10 5 Vel.
BRG0154	-	SATURN / CHEVROLET			CHEVROLET / SATURN Ion L4 2.2L 03-07

# Item	Referencia	Marca(s)	A	B	Aplicación
BRG0157	-	CHEVROLET			CHEVROLET Aveo (China) L4 1.5L L2B 2018 -> 5 Vel.
BRG0159	4R33-7A508-AA	FORD			FORD Mustang GT, ST V6 4.0L 05-10 5 Vel. FORD Mustang GT V8 5.4L 08-13 6 Vel. FORD Mustang GT V8 4.6L 05-10 5 Vel.
BRG016	30502-21000	NISSAN			NISSAN Sakura L4 1.8L 82-93 NISSAN Samurai L4 1.8L 82-93 NISSAN Ichi-Van Pickup L4 1.8L 82-93 NISSAN Pathfinder V6 3.0L 87-95 NISSAN D21 V6 3.0L 86-94 NISSAN Pickup V6 3.0L 95-96
BRG0162	306A1-JK40C	NISSAN			DODGE Avenger L4 2.0L 08-10 5 Vel. DODGE Caliber L4 1.8L 2007 5 Vel. DODGE Caliber L4 2.0L 2007 5 Vel. DODGE Caliber L4 2.4L 08-12 5 Vel. JEEP Compas L4 2.4L 07-17 5 Vel. JEEP Patriot L4 2.4L 07-16 5 Vel. MITSUBISHI Lancer L4 2.0L 08-16 5 Vel. MITSUBISHI Lancer GTS L4 2.4L 09-10 5 Vel. MITSUBISHI Eclipse GT V6 3.8L 06-09 6 Vel. MITSUBISHI L200 2.4L TURBO DIESEL 2020-> 6 Vel.
BRG0163	306A1-JK40C	NISSAN			NISSAN 370Z V6 3.7L 09-16 6 Vel. NISSAN 370Z V6 3.7L 17-19 6 Vel.
BRG0164	-	TOYOTA			TOYOTA Tundra; V6 4.0L 05-06 TOYOTA Tacoma V6 4.0L 05-11 6 Vel. TOYOTA FJ Cruiser V6 4.0L 07-10
BRG0166	30620-00Q0H 306A0-JA60B 306A0-JA60C 32150-00QAC 32150-00QAA 306A0-JA60D	NISSAN			NISSAN Sentra SE-R L4 2.5L 07-12 6 Vel. NISSAN Sentra L4 2.0L DOHC 07-12 5 Vel. NISSAN Sentra 1.8L 12-15 6 Vel. NISSAN Tiida L4 1.8L DOHC 07-18 5 Vel. NISSAN Juke L4 1.6L Turbo 12-14 6 Vel. RENAULT Fluence L4 2.0L 11-17 6 Vel. RENAULT Duster L4 2.0L 2012 -> 6 Vel.
BRG0167	-	CHEVROLET			CHEVROLET Corvette V8 6.2L 10-13

# Item	Referencia	Marca(s)	A	B	Aplicación
BRG0168	614070	DODGE			DODGE Ram 2500 & 3500 L6 5.9L TDI 95-97 6 Vel. DODGE Ram 2500 & 3500 L6 5.9L TDI 01-04 6 Vel. DODGE Ram 2500 & 3500 V10 8.0L TDI 95-97 6 Vel. DODGE Ram 4000 L6 6.7L TDI 11-13 6 Vel. DODGE Ram 4000 L6 5.9L TDI 06-09 6 Vel.
BRG0170	-	HYUNDAI			HYUNDAI Tucson L4 2.0L 05-09 KIA Sportage L4 2.0L 05-08
BRG0174	31230-60230	TOYOTA			TOYOTA Tacoma V6 4.0L 06-09 6 Vel.
BRG0175	92159965	CHEVROLET			CHEVROLET Camaro SS V8 6.2L, 10-15 6 Vel.
BRG0176	-	CHEVROLET			CHEVROLET LUV L4 2.2L 99-05 5 Vel.
BRG0177	41421-32000	DODGE / HYUNDAI / KIA			DODGE Attitude L4 1.4L 12-14 5 Vel. HYUNDAI Accent L4 1.6L 2017- 6 Vel. HYUNDAI Elantra L4 1.8L 2015- 6 Vel. HYUNDAI Elantra L4 2.0L 08-10 6 Vel. HYUNDAI ix35 / Tucson L4 2.0L 2015- 6 Vel. KIA Rio L4 1.6L 2016-> 6 Vel. KIA Forte L4 2.0L MPI 2016- 6 Vel. KIA Soul L4 1.6L 2016- 6 Vel.
BRG0186	-	FORD			FORD Mustang GT, ST V6 3.7L 11-14 6 Vel. FORD Mustang GT V8 5.0L 11-14 6 Vel.
BRG0191	7700874780	NISSAN			NISSAN Platina L4 1.6L 02-10 5 Vel. NISSAN Aprio L4 1.6L DOHC 08-10 5 Vel. RENAULT Clío L4 1.6L DOHC 02-10 5 Vel. RENAULT Clío L4 2.0L Sport 02-04 5 Vel. RENAULT Kangoo L4 1.6L DOHC 02-10 5 Vel. RENAULT Kangoo L4 1.5L Diesel 09-10 5 Vel. RENAULT Kwid L3 1.0L 2019 - > 5 Vel. RENAULT Logan L4 1.6L 15-16 5 Vel. RENAULT Megane L4 2.0L 01-04 5 Vel. RENAULT Sandero L4 1.6L DOHC 10-15 5 Vel. RENAULT Scenic L4 2.0L 01-04 5 Vel. RENAULT Stepway L4 1.6L DOHC 10-15 5 Vel.

COLLARINES & CSC



# Item	Referencia	Marca(s)	A	B	Aplicación
BRG0192	-	FOTON / DFSK			FOTON K01 K01H & K02 L4 1.3L 15-19 5 Vel.
BRG0199	8-97255313-0	ISUZU			ISUZU ELF 200 L4 3.0L Turbo Diesel 09-19 5 Vel. ISUZU ELF 300 L4 3.0L Turbo Diesel 08-19 5 Vel.
BRG0200	614127	MAZDA			MAZDA 2 L4 1.5L 12-14 5 Vel. MAZDA 2 "R" L4 1.5L SKYACTIV-G 15-16 6 Vel.
BRG0201	1-31310012-0	ISUZU			ISUZU ELF 400 L4 5.2L Turbo Diesel 07-19 6 Vel. ISUZU ELF 450 L4 5.2L Turbo Diesel 07-19 6 Vel. ISUZU ELF 500 L4 5.2L Turbo Diesel 07-19 6 Vel. ISUZU ELF 600 L4 5.2L Turbo Diesel 07-19 6 Vel. ISUZU ELF 600-BUS L4 5.2L Turbo Diesel 07-19 6 Vel. ISUZU FORWARD FRR 800 L4 5.2L Turbo Diesel 10-13 6 Vel.
BRG0202	MN171419	MITSUBISHI			MITSUBISHI L200 L5 2.5L Diesel 08-19 5 Vel.
BRG0203EX	31230-BZ060	TOYOTA			TOYOTA Avanza L4 1.5L 07-18 5 Vel. (Incluye Seguros)
BRG0204	93317724	CHEVROLET			CHEVROLET Corsa L4 1.8L 5 Vel.03-08 CHEVROLET Meriva L4 1.8L 5 Vel.03-08 CHEVROLET Tornado L4 1.8 L 04-11 CHEVROLET Astra L4 2.0L 16V 04-06
BRG0206	614015	VOLKSWAGEN			VOLKSWAGEN Pointer 97-10 L4 1.8L, 2.0L 5 Vel. VOLKSWAGEN Pointer 97-10 L4 2.0L 5 Vel. VOLKSWAGEN Pointer GTI L4 2.0L 00-03 5 Vel. VOLKSWAGEN Sedan, Combi & Panel L4 1.6L 74-03 VOLKSWAGEN Corsar L4 1.6L 84-88

COLLARINES & CSC



# Item	Referencia	Marca(s)	A	B	Aplicación
BRG0207	-	JEEP			JEEP Todos L6 4.2L 1980-1986
BRG0208	96518531	PONTIAC / CHEVROLET			PONTIAC Matiz L4 1.0L 04-15 5 Vel. CHEVROLET Beat L4 1.2L 2018-> 5 Vel. CHEVROLET Spark L4 1.2L 11-17 5 Vel.
BRG0209	614172	CHEVROLET			CHEVROLET Chevy C2 L4 TBI 1.6L 04-08 CHEVROLET Chevy C3 L4 MPFI 1.6 L 09-12 CHEVROLET Chevy Joy & Pop TBI 1.4L 94-02 CHEVROLET Chevy Swing L4 TBI 1.6 L 96-03 CHEVROLET Chevy Monza TBI 1.4L 96-02 CHEVROLET Chevy Monza L4 TBI 1.6 L 96-02
BRG0210	30620-00Q0A 30620-00Q0E 30620-00Q0J 30620-00QAB 30620-BN700 30620-BN710	NISSAN			NISSAN Versa L4 1.6L 11-19 5 Vel. NISSAN March L4 1.6L 12-19 5 Vel. NISSAN Note L4 1.6L 14-19 5 Vel. NISSAN Tiida L4 1.6L 13-19 5 Vel. NISSAN Micra L4 1.4L 05-07 5 Vel. NISSAN Sentra Sport Road (SR) L4 2.5L 11-12 6 Vel. RENAULT Logan L4 1.6L 2017 -> 5 Vel.
BRG0211	-	HYUNDAI			HYUNDAI Atos L4 1.0L 01-04 5 Vel. HYUNDAI Atos L4 1.1L 05-12 5 Vel. HYUNDAI i10 L4 1.1L 12-14 5 Vel. HYUNDAI Grand i10 L4 1.2L 15-20 5 Vel.
BRG0212	23265-68L20	SUZUKI			SUZUKI Swift L4 1.4L 12-17 5 Vel.
BRG0213	R201 / 1625	FORD			FORD F-150, F-200, F-250 & F-350 V8 4.7L, 5.0L, 5.8L 4 Vel. 65-91 FORD Fairmont V8 4.7L, 4.9L & 5.0L 78-83 3 & 4 Vel., FORD Mustang V8 5.0L & 5.7L 65-84 3 & 4 Vel.
BRG0214	41412-49600	DODGE			DODGE H-100 L4 2.4L 03-10 5 Vel. DODGE H-100 L4 2.5L Diesel 06-10 5 Vel. DODGE H-100 VAN L4 2.4 L 12-14 5 Vel. DODGE H-100 VAN L4 2.4L & L4 2.5L Diesel 10-14 5 Vel. HYUNDAI Starex L4 2.4L 2018-> 5 Vel.
BRG0215	L503-16-510	MAZDA			MAZDA 3 S L4 2.5L 12-13 6 Vel. MAZDA Speed L4 2.3L Turbo 08-13 6 Vel. MAZDA 3 SKYACTIV-G L4 2.0L 14-18 6 Vel. MAZDA 3 Touring L4 2.5L SKYACTIV-G 15-18 6 SP MAZDA MX-5 L4 2.0L SKYACTIV-G 16-19 6 Vel.

COLLARINES & CSC



# Item	Referencia	Marca(s)	A	B	Aplicación
BRG0216	0C6-141-671 0C6-141-671-C 0C6-141-671-D	VOLKSWAGEN			VOLKSWAGEN Amarok L4 2.0L Turbo 13-14 6 Vel. VOLKSWAGEN Amarok L4 2.0L Bi-Turbo Diesel 11-17 6 Vel.
BRG0217	31230-37050	HINO			HINO Serie 300 - 716 L4 4.0L Turbo Diesel 09-19 6 Vel. HINO Serie 300 - 816 L4 4.0L Turbo Diesel 09-19 6 Vel.
BRG0218	31230-36200	HINO			HINO Serie 300 414 L4 4.0L Turbo Diesel 09-11 5 Vel. HINO Serie 300 514 L4 4.0L Turbo Diesel 12-19 5 Vel. HINO Serie 300 614 L4 4.0L Turbo Diesel 09-11 5 Vel.
BRG0219	-	PEUGEOT			PEUGEOT 206 XR L4 1.4L 99-09 5 Vel. PEUGEOT 206 XS L4 1.6L 01-08 5 Vel. PEUGEOT 306 SR L4 1.6L 97-98 5 Vel.
BRG0220	-	VW / SEAT			AUDI A1 L4 1.4L TFSI 2011 - 6 Vel. AUDI A3 L4 1.4L TFSI 2008 - 6 Vel. BAIC D20 L4 1.5L 17-20 5 Vel. BAIC X25 L4 1.5L 16-20 5 Vel. SEAT Altea L4 1.4L TFSI 10-12 6 Vel. SEAT Córdoba L4 1.6L 04-09 5 Vel. SEAT Ibiza L4 1.6L 04-09 SEAT Ibiza L4 1.2L TSI 13 - 5 Vel. SEAT Leon L4 1.4L TSI 2008 - 6 Vel. SEAT Toledo L4 1.2L TSI 13 - 6 Vel. SEAT Toledo L4 1.6L 13 - 5 Vel. VW Caddy L4 1.2L TSI 14-15 5 Vel. VW Crossfox L4 1.6L 2006 - 5 Vel. VW Gol L4 1.6L 2009 - 5 Vel. VW Lupo L4 1.6L 05-09 5 Vel. VW Polo L4 1.2L TSI 13-14 6 Vel. VW Polo L4 1.6L 03-07 5 Vel. VW Saveiro L4 1.6L 10-16 5 Vel. VW Sport Van L4 1.6L 07-10 5 Vel. VW UP L3 1.0L 2016- 5 Vel. VW Vento L4 1.6L 14-20 5 Vel. VW Virtus L4 1.6L 2020-> 5 Vel.
BRG0222	-	TOYOTA			TOYOTA Corolla L4 1.8L 14-21 6 Vel.

COLLARINES & CSC



# Item	Referencia	Marca(s)	A	B	Aplicación
BRG0224	-	FREIGHT-LINER / STERLING			FREIGHTLINER 360 -715 L4 4.9L Turbo Diesel 07-19 5 Vel. STERLING 360 L4 4.9L Turbo Diesel 07-20 5 Vel. FREIGHTLINER FL 360 -715TF L4 3.0L 4P10-KAT4 Turbo Diesel 2020-> 5 Vel.
BRG0226	-	FAW			FAW GF8 L4 1.0L 07-12 5 Vel. FAW GF60 L4 1.3L 16- 5 Vel. FAW GF900 L4 1.0L 07-12 5 Vel. FAW GF1500 L4 1.5L 16- 5 Vel. CBO 1000 L4 1.0L TURBO 11-15 5 Vel.
BRG0227	-	DODGE / MITSUBISHI			MITSUBISHI Mirage L3 1.2L 15-19 5 Vel. DODGE Attitude L4 1.2L 15-20 5 Vel. FAW F5 L4 1.5L 08-11 5 Vel.
BRG0228	-	PEUGEOT			PEUGEOT 207 L4 1.4L 08-11 5 Vel. PEUGEOT 207 L4 1.6L 08-11 5 Vel. PEUGEOT Grand Raid L4 1.6L 07-12 5 Vel. PEUGEOT Partner L4 1.6L 03-12 5 Vel.
BRG0229	-	HINO			HINO Serie 500 - 1018 L4 4.7L Turbo Diesel 09-19 6 Vel. HINO Serie 500 BUS BF918G L4 5.1L Turbo Diesel 2018 -> 6 Vel. HINO Serie 500 BUS BF918K L4 5.1L Turbo Diesel 2018 -> 6 Vel. INTERNATIONAL Clase 4 & 5 CityStar L4 3.8L Turbo Diesel 13-19 6 Vel. (Set # FT805204U)
BRG0230	3124-21060	HINO			HINO Serie 500 - 1524 L6 7.7L Turbo Diesel 09-19 6 Vel. HINO Serie 500 - 1724 L6 7.7L Turbo Diesel 09-19 6 Vel. HINO Serie 500 - 1727 L6 7.7L Turbo Diesel 09-19 6 Vel. HINO Serie 500 - 2627 L6 7.7L Turbo Diesel 09-19 6 Vel. HINO Serie 500 BUS - BF1524M L6 7.7L Turbo Diesel 2018-> 9 Vel. HYUNDAI Aero Town L6 6.6L Diesel 13-19 5 Vel. HYUNDAI Super Aero City (Ecobus) L6 6.0L GNC (GAS NATURAL) 13-19 5 Vel. HYUNDAI H120 / D6GA25 CLASE 7 L6 5.9L 2011-> 6 Vel.
BRG0231	-	FORD			FORD Fiesta L4 1.6L 11-19 5 Vel. FORD Ikon L4 1.6L 12-15 5 Vel. FORD Figo L4 1.6L 16-20 5 Vel.

COLLARINES & CSC



# Item	Referencia	Marca(s)	A	B	Aplicación
BRG0232	-	FOTON / NAVISTAR			FOTON Aumark 7000 L4 3.8L Turbo Diesel 08-18 6 Vel. (Set # FT808206)
BRG0233	-	FOTON			FAW GF5000 L4 1.5L Turbo Diesel 6 Vel. 16- FOTON Aumark 2000 L4 2.8L (86kw) 08-18 5 Vel. FOTON Aumark 3000 L4 2.8L (96kw) 08-18 5 Vel. FOTON Aumark 5000 L4 3.8L 08-18 6 Vel. FOTON Aumark 6000 L4 3.8L 08- 6 Vel. INTERNATIONAL Clase 3 CityStar L4 3.8L ISF 13-19 6 Vel. INTERNATIONAL Clase 5 CityStar L4 3.8L ISF 13-19 6 Vel.
BRG0234	23820-79J00	SUZUKI			SUZUKI Swift Sport L4 1.6L 13-17 6 Vel. SUZUKI Swift Boosterjet L3 1.0L 17-> 5 Vel. SUZUKI S-Cross L4 1.6L 14-18 5 Vel. SUZUKI Vítara GLS L4 1.6L 16-17 5 Vel. SUZUKI Vítara L4 1.4L Turbo 17-20 6 Vel. SUZUKI SX-4 L4 2.0L 08-09 5 Vel. SUZUKI SX-4 L4 2.0L 10-14 6 Vel.
BRG0235	-	NISSAN			NISSAN Frontier L4 2.4L 00-08 5 Vel. NISSAN Frontier NP300 L4 2.5L 16-19 6 Vel. NISSAN Frontier NP300 L4 2.5L Diesel 16-19 6 Vel. NISSAN Ichi Van L4 2.4L 92-94 5 Vel. NISSAN NP300 L4 2.4L 09-13 5 Vel. NISSAN NP300 L4 2.5L 16-19 6 Vel. NISSAN NP300 L4 2.5L Diesel 16-19 6 Vel. NISSAN Pickup 720 83-92 L4 2.4L 5 Vel. NISSAN Pathfinder L4 2.4L Z24 L 86-93 5 Vel. NISSAN Urvan L4 2.4L 00-07 5 Vel. NISSAN Urvan L4 2.5L 08-13 5 Vel. NISSAN Urvan NV350 L4 2.5L 14-16 5 Vel. NISSAN Urvan NV350 L4 2.5L Diesel 14-19 5 Vel. NISSAN Xterra L4 2.4L 00-04 5 Vel.
BRG0236	-	SUZUKI			SUZUKI Swift L4 1.2L 2018-> 5 Vel. SUZUKI Ignis L4 1.2L 2017-> 5 Vel.
BRG0237	-	TOYOTA			TOYOTA Hilux L4 2.7L 16-20 5 Vel.
BRG0238	-	TOYOTA			TOYOTA Hilux L4 2.7L Diesel 16-19 6 Vel. TOYOTA Hiace L4 2.8L Diesel 2020-> 6 Vel.

COLLARINES & CSC



# Item	Referencia	Marca(s)	A	B	Aplicación
BRG0239	510022810	CHEVROLET			CHEVROLET Sonic L4 1.6L 12-17 5 Vel. CHEVROLET Trax L4 1.8L 13-17 5 Vel.
BRG0240	-	SUZUKI			SUZUKI Ciaz L4 1.4L 15-20 5 Vel.
BRG0241	510017510	CHEVROLET			CHEVROLET Cruze L4 1.8L 09-15 5 Vel.
BRG0242	-	FORD			FORD Focus ST L4 2.0L Turbo 13-15 6 Vel.
BRG0243	-	INTERNATIONAL / NAVISTAR			INTERNATIONAL CITY STAR CLASE 3 L4 2.8L (MOTOR CHINA) TURBO DIESEL 2013- 5 SP (Set # JA803203)
BRG091	8540-16-510	MAZDA / FORD			MAZDA Pickup B2600 L4 2.6L 89-93 MAZDA Pickup B2600I L4 2.6L 89-93 MAZDA Pickup B2200 L4 2.2L 87-93 (Solo USA) MAZDA 626 L4 2.0L 93-00 MAZDA 626 V6 2.5L 93-01 MAZDA MX-6 L4 2.0L 93-00 MAZDA MX-6 V6 2.5L 93-01 FORD Probe V6 2.5L 93-97
BRG201	90363-40001	TOYOTA			TOYOTA Pickup L4 2.4L 22R & 22RE 85-88
BRG210	614126	MITSUBISHI / CHRYSLER			MITSUBISHI Eclipse L4 2.0L 90-94 2WD CHRYSLER Colt L4 1.6L Turbo 5 Vel. 89-90 CHRYSLER Colt L4 1.8L 89-93 CHRYSLER Colt L4 2.0L 85-91 MITSUBISHI Eclipse L4 2.4L 06-12 5 Vel. MITSUBISHI Lancer Ralliart; L4 2.4L 03-06 6 Vel. MITSUBISHI Lancer L4 2.0L, 120 HP 04-07 CHRYSLER Stratus L4 2.4L 01-05 5 Vel. MITSUBISHI Eclipse L4 2.4L 01-05

COLLARINES & CSC



# Item	Referencia	Marca(s)	A	B	Aplicación
BRG218	614022	NISSAN			NISSAN Tsuru I L4 1.5L 84-87 4 Vel. NISSAN Tusuru II L4 1.6L 88-91 4 Vel. NISSAN Hikari Coupé L4 1.6L 87-92 Carburado NISSAN Ninja L4 1.6L Turbo 1987
BRG350	614016	HYUNDAI / MITSUBISHI			DODGE Van 1000 L4 2.4L 2008 5 Vel. HYUNDAI H-100 Van 1000 L4 2.4L 2008 5 Vel. MITSUBISHI L200 L4 2.4L 08-19 5 Vel.
BRG371	614043	TOYOTA			TOYOTA Yaris L4 1.3L 04-05 5 Vel.
BRG403	-	CHEVROLET			CHEVROLET LUV L4 2.3L 97-98 5 Vel.
BRG426	31230-B4010	TOYOTA			TOYOTA Rush L4 1.5L 2009 5 Vel.
BRG427	614077	HONDA			HONDA Civic L4 1.5L 90-91 5 Vel. HONDA Civic L4 1.6L 90-91 5 Vel.
BRG433E	614047	NISSAN			NISSAN Lucino GSE L4 1.6L 99-00 5 Vel. NISSAN Sentra GST & GSX L4 1.6L 96-00 5 Vel. NISSAN Tsuru III L4 1.6L 92-17 5 Vel. NISSAN Tsubame L4 1.6L 93-05 5 Vel.
BRG437	614124	NISSAN			NISSAN Almera L4 1.8L 01-05 5 Vel. NISSAN Altima L4 2.4L 98-01 6 Vel. NISSAN Sentra L4 1.8L 01-06 5 Vel. NISSAN Sentra GSS L4 2.0L 96-01 5 Vel. NISSAN Lucino GSR L4 2.0L 96-00 5 Vel. NISSAN Tsuru GSR L4 2.0L 93-96 5 Vel. NISSAN NP300 (D22) L4 2.5L Diesel 09-13 5 Vel.
BRG438	614056	CHEVROLET			SUZUKI Aerio L4 2.3L 06-07 5 Vel. SUZUKI Samurai L4 1.3L 86-95 5 Vel. FAW GF8 L4 1.0L 13-16 5 Vel. FAW GF900 L4 1.0L 13-16 5 Vel. CBO 1500 L4 1.1L TURBO DIESEL 2014 5 Vel.

COLLARINES & CSC



# Item	Referencia	Marca(s)	A	B	Aplicación	
BRG440	Nacional	-	HYUNDAI			HYUNDAI H200 L4 2.5L Turbo Diesel 2017 - 5 Vel. HYUNDAI Super Aereo City (Autobus) 08EM L6 5.9L Diesel 10- 17 6 Vel.
BRG442	Nacional	614084	TOYOTA			TOYOTA MR2 L4 2.2L 91-95 TOYOTA Camry L4 2.0L 1991 TOYOTA Camry L4 2.2L 92-01
BRG443	Nacional	-	TOYOTA / LEXUS			TOYOTA Supra L6 3.0L 94-97 LEXUS IS300 L6 3.0L 02-03 LEXUS SC300 L6 3.0L 92-97
BRG444	Nacional	614088	HONDA			TOYOTA Hiace L4 2.7L 06-19 5 Vel. TOYOTA Hilux L4 2.7L 06-15 5 Vel. TOYOTA Tacoma L4 2.4L 01-04 2RZFE / 4WD 5 Vel. TOYOTA Tacoma L4 2.7L 95-04 5 Vel. TOYOTA T100 L4 2.7L 94-04 5 Vel.
BRG445	Nacional	614086	TOYOTA			TOYOTA Pickup 22R L4 2.4L 85-94 5 Vel. TOYOTA Pickup V6 3.0L 90-95 5 Vel.
BRG451	Nacional	-	TOYOTA			TOYOTA Corolla XRS L4 2.4L 09-13 5 Vel. TOYOTA Matrix XR L4 2.4L 09-10 5 Vel. TOYOTA MR2 Turbo L4 2.0L 91-95 TOYOTA Camry V6 3.0L 92-01
BRG452	Nacional	-	FORD / MAZDA			FORD Escape L4 2.0L 01-04 FORD Escort L4 2.0L 97-01 5 Vel. FORD Escort ZX2 L4 2.0L 98-01 5 Vel. FORD Fusion L4 2.3L 07-08 5 Vel. MAZDA 6 L4 2.3L 06-08 5 Vel. MAZDA 6 V6 3.0L 06-08 6 Vel. MAZDA 6 i Sport L4 2.5L 09-13 6 Vel. MAZDA MX-5 Miata L4 2.0L 06-14 6 Vel. MAZDA MX-5 Sport L4 2.0L 05-10 6 Vel.
BRG453	Nacional	614128	FORD			FORD Escort L4 1.9L 1994-1996

# Item	Referencia	Marca(s)	A	B	Aplicación
BRG454	614082	SUZUKI			SUZUKI Swift L4 1.5L 07-11 5 Vel. CHEVROLET Geo Metro L4 1.3 L 92-20 CHEVROLET Geo Metro L4 1.0 L 89-97
BRG493	-	HYUNDAI			HYUNDAI HD65 L4 3.9L Turbo Diesel 16- 5 Vel. HYUNDAI 300 L4 3.9L Turbo Diesel 2017 - 5 Vel. HYUNDAI 400 L4 3.9L Turbo Diesel 2017 - 5 Vel. HYUNDAI 500 L4 3.9L Turbo Diesel 2017 - 5 Vel. FREIGHTLINER FL 360 -715TF L4 3.0L 4P10 Turbo Diesel 14-19 5 Vel.
BRG500	614179	HONDA / ACURA			ACURA RSX L4 2.0L 02-06 5 & 6 Vel. HONDA Accord L4 2.4L 03-11 6 Vel. HONDA Accord Coupe V6 3.0L 03-07 6 Vel. HONDA Accord Coupé V6 3.5L 2013 6 Vel. HONDA Civic EX L4 2.0L 16-20 6 Vel. HONDA Civic SI L4 2.0L 02-11 6 Vel. HONDA Civic SI L4 2.4L 12-15 6 Vel. HONDA CRV L4 2.4L 03-09 5 Vel. HONDA Element L4 2.4L 03-09 5 Vel. HONDA HRV L4 1.8L 15-18 Vel.
BRG601	30502-AA080	SUBARU			SUBARU Impreza WRX STI Turbo H4 2.5B 07-11 6 Vel. MITSUBISHI Lancer L4 2.0L Turbo 03-06 6 Vel. MITSUBISHI Lancer Evo IX MR L4 2.0L 03-07 6 Vel. MITSUBISHI Eclipse GT V6 3.0L 00-05
BRG603	8-94377-417-0	ISUZU			ISUZU Rodeo V6 3.2L 94-04
BRG809	614049	NISSAN			NISSAN Altima SE-R V6 3.5L 05-06 6 Vel. NISSAN Maxima V6 3.0L 85-01 6 Vel.
BRG810	613015	NISSAN			NISSAN Pickup D21 L4 2.4L 94-12 NISSAN Pathfinder L4 2.4L 86-93 NISSAN Pickup 720 L4 2.4L 83-92 NISSAN 300 ZX V6 3.0L 89-96 NISSAN 240SX L4 2.4L 91-98
BRG817	-	HONDA			ACURA CL L4 2.2L, 2.3L 97-99 HONDA Accord L4 2.2L 90-97 HONDA Accord L4 2.3L 98-02 6 Vel. HONDA Civic SIR L4 1.6L VTEC 99-00 5 Vel. HONDA Prelude L4 2.0L 88-89
BRG820	614122	HONDA			HONDA Civic L4 1.5L 92-95 5 Vel. HONDA Civic EX-R L4 1.6L 92-00 5 Vel. HONDA Civic L4 1.7L 01-05 5 Vel. HONDA Civic L4 1.8L 06-16 5 Vel. HONDA City L4 1.5L 09-19 5 Vel. HONDA Fit L4 1.5L 06-14 5 Vel. HONDA Fit L4 1.5L 2015-> 6 Vel.

# Item	Referencia	Marca(s)	A	B	Aplicación
BRG833	614159	SUBARU			SUBARU Impreza H4 2.0i 08-17 5 Vel. SUBARU Impreza H4 2.5i 08-17 5 Vel.
BRG840	614152	TOYOTA			TOYOTA Corolla L4 1.8L 03-13 5 Vel. TOYOTA Matrix XR L4 1.8L 03-11 5 Vel. TOYOTA Matrix XRS L4 1.8L 04-08 6 Vel. TOYOTA MR2 Spyder L4 1.8L 05-06 6 Vel. TOYOTA Yaris L4 1.5L 17-20 5 Vel.
BRG844	614049	NISSAN			NISSAN Altima L4 2.4L 93-97 5 Vel. NISSAN Sentra SE-R L4 2.5L 02-06. NISSAN Urvan Diesel L4 3.0L 08-13 5 Vel.
BRG902	614162	TOYOTA			TOYOTA Tacoma V6 3.4L 2005
BRG903	31230-36210	HINO			HINO Serie 300 - 616 L4 4.0L Turbo Diesel 09-19 5 Vel. HINO Serie 300 - 716 L4 4.0L Turbo Diesel 2008 6 Vel. HINO Serie 300 - 816 L4 4.0L Turbo Diesel 2008 6 Vel.
CSC100	510001111	FORD			FORD Courier L4 1.6L 01-12 5 Vel. (Incluye CSC C/ Adaptador (11.1mm ó 9.5 mm)) FORD Focus (Argentina) L4 2.0L 05-08 5 Vel. (Incluye CSC C/Adaptador (11.1mm ó 9.5 mm)) FORD Ikon L4 1.6L 03-11 5 Vel. (Incluye CSC C/Adaptador (11.1mm ó 9.5 mm)) FORD Fiesta L4 1.6L 01-10 5 Vel. (Incluye CSC C/ Adaptador (11.1mm ó 9.5 mm)) FORD Ka L4 1.6L 01-08 5 Vel. (Incluye CSC C/Adaptador (11.1mm ó 9.5 mm)) FORD EcoSport L4 2.0L 04-08 5 Vel. (Incluye CSC C/ Adaptador (11.1mm ó 9.5 mm))"
N1463	CD1186CA-8830	DODGE			DODGE 100-350, 1500-2500 VAN V8 5.2L 77-83 DODGE 100-350, 1500-2500 VAN V8 5.2L 84-87 DODGE D100-350, R1500-3500 (RAM) V8 5.2L 77-85

COLLARINES & CSC



# Item	Referencia	Marca(s)	A	B	Aplicación
N1714SA	614014	FORD			FORD Microbus P350 V8 5.8L 91-97 FORD Mustang V6 3.8L 94-04 5 Vel. FORD Mustang V6 4.6L 96-04 5 Vel. FORD Mustang V6 5.0L 86-95 5 Vel. FORD Bronco L6 5.0L 84-93 4 Vel. FORD F-100 L6 4.9L 84-93 4 Vel. FORD F-150 V6 3.8L, 88-94 FORD F-250 L6 4.9L 83-93 4 Vel. FORD F-250 V8 5.0L 92-97 FORD F-250 LOBO V8 5.8L 1995 FORD F-350 V8 5.0L 92-98 FORD F-350 V8 5.8L 90-98
N1716SA	614018	CHEVROLET			CHEVROLET Microbus (P-300) V8 5.7L 85-96 4 Vel. CHEVROLET Blazer, S10, T10 Maxicab V6 3.1L 83-93 CHEVROLET Jimmy, S15, T15, Sonoma L4 2.0L 83-84 CHEVROLET Sonoma L4 2.5L 85-93 CHEVROLET Sonoma V6 2.8L 85-93 CHEVROLET Camaro, Firebird, Corvette 67-95 CHEVROLET C1500, C2500 & C3500 V8 6.5L TDI 92-95
N1725SA	614009	CHEVROLET			CHEVROLET Cavalier V6 2.8L 85-86
N1753	614062 E7TZ 7548 A	FORD			FORD F-700 GASOLINA, GAS V8 7.0L 1998 FORD Super Duty V8 7.3L & 7.5L Turbo Diesel 87-98 FORD Super Duty F-250 & F350 V8 7.3L Turbo Diesel 87-94
N1756SA	4505 358	DODGE / CHRYSLER			DODGE D250 & D350 V8 5.9L 88-90 DODGE D250 & D350 V8 5.9L Transmisión TREMEC 88-91
N8031	614111	VOLKSWAGEN			Audi A3 L4 1.8L Turbo 99-04; Audi A3 L4 1.8L TFSI 07-10 Audi A3 L4 2.0L TFSI 04-07; Audi A3 L4 2.0L FSI 04-07 Audi TT L4 1.8L Turbo 04-06; Audi TT L4 1.8L TFSI 11-12 Seat Altea L4 2.0L FSI 05-06 Seat León L4 1.4L TSI 14-15 Seat León L4 1.8L 01-06; Seat León L4 1.8L TSI 08-13 Seat León L4 2.0L FSI 06-09 Seat Toledo L4 1.8L 01-05; Seat Toledo L4 2.0L 2006 VW Beetle L4 1.8L Turbo 00-05; VW Beetle L4 2.0L 98-11 VW Beetle L4 2.5L 06-18 VW Bora L4 1.9L TDI 08-10; VW Bora L5 2.5L 06-10 VW Cabrio L4 2.0L 00-02 VW Derby L4 2.0L 01-04 VW Golf L4 1.4L TSI 13-19 VW Golf L4 1.8L Turbo 00-03 VW Golf L4 2.0L 96-07 VW Golf VR6 V6 2.8L 95-99 VW Jetta V6 2.8L VR6 95-99 VW Jetta A4 L4 1.8L Turbo 02-12; VW Jetta A4 L4 1.9L

COLLARINES & CSC



# Item	Referencia	Marca(s)	A	B	Aplicación
N8031	614111	VOLKSWAGEN			Turbo 06-13 VW Jetta / Clásico A4 L4 2.0L 99-15 VW Jetta A6 L4 2.0L 13-18; VW Jetta A6 L5 2.5L 11-18 VW Jetta A3 VR6 V6 2.8L 95-99 VW Passat VR6 V6 2.8L 96-01 VW Vento L4 1.5L Diesel 14-18 VW Eurovan L4 1.9L 05-09 5 Vel. ; VW Eurovan L5 2.5L 00-04 5 Vel. VW Transporter L4 2.0L TDI 10-> VW Van L4 1.8L 03-09 5 Vel."SUBARU Impreza H4 2.0i 08-17 5 Vel. SUBARU Impreza H4 2.5i 08-17 5 Vel.
N8074	614070	DODGE			DODGE Dakota L5 2.5L 5 Vel. Trans. NEW PROCESS 96-97 DODGE Dakota V6 3.9L D150, D350 92-99 JEEP Liberty L4 2.4L 02-04 5 Vel. JEEP Liberty V6 3.7L 02-04 5 Vel. JEEP Wrangler L6 3.8L 07-13 6 Vel.
N8096	614169	FORD			FORD Ranger L4 2.3L 93-95
N8105	619006 22638960	CHEVROLET			CHEVROLET Cavalier L4 2.2L MPFI, DOHC 95-00 5 Vel. CHEVROLET Cavalier L4 2.3L 1995 5 Vel. CHEVROLET Cavalier L4 2.4L 95-00 5 Vel. CHEVROLET Cavalier Z24 L4 2.4L 95-96 PONTIAC J2000 L4 2.2L MPFI, DOHC 95-99 5 Vel. PONTIAC J2000 L4 2.3L 1995 PONTIAC Sunbird L4 2.2L MPFI, DOHC 95-99 5 Vel. PONTIAC Sunbird L4 2.3L 1995 PONTIAC Sunfire L4 2.2L MPFI, DOHC 95-99 5 Vel. PONTIAC Sunfire, Z69 L4 2.4L 1995
N8106	167703B	ISUZU			ISUZU Rodeo V6 3.2L 92-93
N8126	614175	FORD			FORD F-250 V8 7.3L Diesel Power Stroke 99-03 FORD F-350 V8 7.3L Diesel Power Stroke 99-03 FORD F-450 Super Duty V10 6.8L Triton 99-09 FORD F-450 Super Duty V8 7.3L Diesel Power Stroke 99-03 FORD F-550 Super Duty V10 6.8L Triton 01-08 FORD F-550 Super Duty V8 7.3L Diesel Power Stroke 99-03

COLLARINES & CSC



# Item	Referencia	Marca(s)	A	B	Aplicación
N8132	-	CHRYSLER / DODGE			CHRYSLER Neon L4 2.0L 94-05 5 Vel. CHRYSLER PT Cruiser L4 2.4L 00-10 5 Vel.
N8133	SC140319 22602575	CHEVROLET			CHEVROLET Cavalier L4 2.2L SOHV SFI 00-02 5 Vel. CHEVROLET Cavalier L4 2.2L DOHC ECOTEC 02-05 CHEVROLET Cavalier L4 2.4L 00-02 5 Vel. PONTIAC Grand AM L4 2.2L DOHC ECOTEC 02-04 PONTIAC Grand AM L4 2.4L 00-01 5 Vel. PONTIAC Sunbird L4 2.2L DOHC ECOTEC 02-05 PONTIAC Sunfire L4 2.2L DOHC ECOTEC 02-05 PONTIAC Sunfire L4 2.4L 00-02 5 Vel. PONTIAC J2000 L4 2.2L DOHC ECOTEC 02-05



**VOLANTES
MOTRICES**

VOLANTES MOTRICES



# Item	A	B	Marca	ProKit #	Aplicación	Dientes	OE #
CRF501			JEEP	05065	JEEP Wrangler V6 4.0L 91-04 JEEP Grand Cherokee V6 4.0L 93-96 JEEP Comanche V6 4.0L 91-92 JEEP Cherokee V6 4.0L 94-01	164	53020519AB 4160162900
CRF502			JEEP	01040	JEEP Cherokee L4 2.5L 91-00 JEEP Comanche L4 2.5L 91-92 JEEP Wrangler L4 2.5L 93-02	148	53020578
CRF512			JEEP	05065	JEEP Wrangler V6 4.0L 05-06	164	53010630AB
FMF500			FORD	07042	FORD Mustang V8 5.0L 86-95	157	E6ZZ6375A
FMF505			FORD	07077 07096	FORD RANGER V6 4.0L 90-97 FORD EXPLORER V6 4.0L 91-97	138	FOTZ6375A 4160147900
FMF507			FORD	KFM06CSC	FORD Ranger XL L4 2.3L 95-12 5 Vel. FORD Ranger XL L4 2.5L 98-01 5 Vel. FORD Ranger XLT V6 3.0L 95-08 5 Vel. MAZDA Serie B 2300 L4 2.3L 95-09 MAZDA Serie B 2500 L4 2.5L 98-01 MAZDA Serie B 3000 V6 3.0L 95-07 FORD F-100 L4 2.5L DURATEC 98-03 FORD F-100 V6 3.0L DURATEC 97-03	132	ZZM4-11-500 F572 6375-B
FMF508			FORD	07054 07099	FORD Ranger V6 3.0L 91-94 FORD Aerostar V6 3.0L 86-94 MAZDA B3000 3.0L 1994 FORD Tempo V6 3.0L 92-94	132	E69Z6375B

VOLANTES MOTRICES



# Item	A	B	Marca	ProKit #	Aplicación	Dientes	OE #
FMF509			FORD	FMK1000	FORD Aerostar 2.8L 86-97 FORD Aerostar V6 4.0L 86-97 FORD Bronco 2.8L, 2.9L & 4.0L 84-90 FORD Explorer V6 4.0L 91-05 FORD Ranger 2.8L, 2.9L & 4.0L 84-11 FORD Mustang V6 4.0L 05-10	138	2L5Z6375AA 4160202900 D2RY6384A
FMF512			FORD	10029	FORD Probe 89-92 2.2L MAZDA B2000 L4 2.0L 86-87 MAZDA B2200 L4 2.2L 88-93 No Turbo MAZDA MX-6 L4 2.0L 1996 MAZDA MX-6 L4 2.2L 88-92 No Turbo MAZDA MX-6 V6 2.5L 1996 MAZDA 626 L4 2.0L 84-87 2.0L No Turbo MAZDA 626 L4 2.0L Turbo 1987 MAZDA 626 L4 2.2L 88-92 No Turbo	112	F80111500A F80711500B
FMF536			FORD	MZK1008	FORD Fusion 08-12 FORD Milan 08-12 MAZDA 6 L4 2.5L DURATEC 09-10 MAZDA 6 V6 3.7L 09-10 MAZDA Tribute L4 2.5L 09-11 MAZDA Tribute V6 3.0L 09-11	-	L50111500B
HCF500			HONDA	KHC05 08028 08017 KHC12	HONDA Civic SiR L4 1.6L 99-00 5 Vel. HONDA CR-V L4 2.0L 98-01 ACURA Integra L4 1.8L 90-01 No V-Tec ACURA Integra 1.7L 92-93 HONDA Civic Si L4 1.6L 99-01 HONDA Civic Del Sol L4 1.6L DOHC 94-97	112	22100-P75-005 22100-P75-000 22100-P75-305 22100-PR4-010 4160045900
HCF502			HONDA	08010 08011	HONDA Civic L4 1.5L 88-89 HONDA Civic L4 1.6L 88-89 HONDA Civic Del Sol L4 1.6L Exc. V-Tec 96-97 HONDA CRX L4 1.8L 88-89 HONDA CRX L4 1.6L 88-91	109	22100PM7010
HCF503			HONDA	08708 08006	HONDA Accord L4 2.0L 86-89 HONDA Prelude L4 1.8L 83-87 HONDA Prelude L4 2.0L 85-87	109	22100PH4A01 4160149900
HCF510			HONDA	HCK1006 HCK1010	HONDA Fit L4 1.5L 06-13 5 Vel HONDA Fit L4 1.5L 15-20 6 Vel HONDA City L4 1.5L 11-19 5 Vel	109	22100-RB0-005

VOLANTES MOTRICES



# Item	A	B	Marca	ProKit #	Aplicación	Dientes	OE #
HCF512			HONDA	KHC10	HONDA Civic SI L4 2.0L 06-11 6 Vel. ACURA RSX Type S 02-07	119	22100-RBC-003
HCF513			HONDA	HCK1009	HONDA ACCORD L4 2.4L 08-12 6 Vel. ACURA TSX 09-14	119	22100-R40-003
HCF514			HONDA	KHC09	HONDA Civic SI L4 2.0L 02-05 6 Vel. ACURA RSX L4 2.0L 02-06 5 & 6 Vel.	119	22100-PND-003
ISF500			ISUZU	KIS01	ISUZU Amigo L4 2.6L 90-94 ISUZU Rodeo L4 2.6L 91-97 ISUZU Rodeo V6 3.2L 94-04 ISUZU Pickup 2.6L 88-95 ISUZU Pickup 2.3L 89-90 HONDA Passport 2.6L 94-96 ISUZU Trooper 88-91	115	8944621012 8-94462-101-2 4160179900
ISF501			ISUZU	04071	ISUZU Amigo L4 2.3L 89-93 ISUZU Impulse L4 1.9L 83-87 2WD ISUZU Impulse L4 2.3L 88-89 2.3L ISUZU Pick up L4 1.9L 85-87 ISUZU Pick up L4 2.2L Diesel 85-87 ISUZU Pick up L4 2.3L 86-95 ISUZU Pick up L4 2.6L 88-90 ISUZU Trooper L4 1.9L 84-85 ISUZU Trooper L4 2.2L 86-87 ISUZU Trooper L4 2.3L 86-87	115	8944251920
ISF502			ISUZU	KIS01	ISUZU Amigo V6 3.2L 98-00 ISUZU Rodeo V6 3.2L 93-04 ISUZU Rodeo Sport V6 3.2L 01-03 ISUZU Trooper V6 3.2L 92-97 ISUZU Trooper V6 3.5L 98-02 HONDA Passport V6 3.2L 94-02	121	22100-RBC-003
MBF500			MITSUBISHI	MBK1000	CHRYSLER Stratus L4 2.4L 01-05 5 Vel. CHRYSLER Sebring L4 2.4L 01-05 5 Vel. MITSUBISHI Eclipse L4 2.4L 00-05 5 Vel. (No Turbo)	-	MD363102 4160254900

VOLANTES MOTRICES



# Item	A	B	Marca	ProKit #	Aplicación	Dientes	OE #
MBF501			MITSUBISHI	05048	MITSUBISHI Eclipse Spyder L4 2.4L 96-99 MITSUBISHI Expo L4 2.4L 93-95 MITSUBISHI Galant L4 2.4L 94-98 2.4L	106	MD188161
MBF504			MITSUBISHI	MBK1009	MITSUBISHI Lancer Evolution GSR L4 2.0L TURBO 08-15 5 Vel. MITSUBISHI Lancer Evolution SR L4 2.0L TURBO 2009 5 Vel.	114	1120A147
MBF508			MITSUBISHI	KMB02	MITSUBISHI Eclipse GT V6 3.0L 2000 MITSUBISHI Eclipse GT & Spyder GT V6 3.0L 01-02	-	MD747799
MZF503			MAZDA	MZK1003 MZK1015	MAZDA 3 L4 2.0L 05-13 5 Vel. MAZDA 3 L4 2.3L 05-13 6 Vel. MAZDA 5 L4 2.3L Sport 05-11 5 Vel.	112	L32711500B
NSF501			NISSAN	06040EXMX KNS05	NISSAN Lucino GSE L4 1.6L 99-00 NISSAN Sentra L4 1.6L 93-00 NISSAN Tsuru III L4 1.6 L 92-17 NISSAN Tsubame L4 1.6L 93-05 NISSAN 200SX L4 1.6L 95-99 NISSAN NX L4 1.6L 91-93 NISSAN Pulsar NX L4 1.6L 89-99	105	12310-F4205 12310-78A56
NSF502			NISSAN	KNS10 06058	NISSAN Frontier L4 2.4L 02-03 NISSAN Frontier V6 3.3L 98-04 No Supercargada NISSAN XTerra V6 3.3L 00-04 NISSAN Pathfinder V6 3.3L 96-01	120	12310-0W001
NSF504			NISSAN	KNS02	NISSAN Almera L4 1.8L 01-05 5 Vel. NISSAN Sentra L4 1.8L 01-06 5 Vel. NISSAN Sentra SE & SE-R L4 2.0L 91-01 5 Vel. NISSAN Lucino GSR L4 2.0L 96-00 5 Vel. NISSAN Maxima V6 3.0L 1990 NISSAN Tsuru GSR L4 2.0L 93-96 5 Vel. NISSAN 200SX L4 2.0L 95-99 INFINITY G20 L4 2.0L 91-02 NISSAN NX L4 2.0L 91-93	109	22100-RB0-005
NSF510			NISSAN	NSK1014HDEX KNS10	NISSAN Frontier L4 2.4L 99-04 NISSAN Frontier V6 3.3L 09-04 (NO SUPERCARGADA) NISSAN Pathfinder V6 3.3L 96-00 (NO SUPERCARGADA) NISSAN XTerra V6 3.3L 00-04 (NO SUPERCARGADA)	-	12310-0W001 12310-0W000

VOLANTES MOTRICES



# Item	A	B	Marca	ProKit #	Aplicación	Dientes	OE #
SZF500			SUZUKI	04104	SUZUKI Samurai L4 1.3L 86-95 SUZUKI Sidekick L4 1.3L 1989	100	1262083000 4160181900
SZF501			SUZUKI	04137	SUZUKI Sidekick L4 1.6L 89-98 SUZUKI Sidekick L4 1.8L 96-98 SUZUKI Vitara L4 1.6L 99-01 SUZUKI X-90 L4 1.6L 96-98	105	1262060A01
TYF501			TOYOTA	16059	TOYOTA Pickup V6 3.0L 88-95 5 Vel. TOYOTA T100 V6 3.0L 93-94 TOYOTA 4Runner L4 2.4L 1989 TOYOTA 4Runner V6 3.0L 90-95	120	1340565010
TYF502			TOYOTA	16087	TOYOTA Tacoma V6 3.4L 95-04 TOYOTA Tundra V6 3.4L 00-05 TOYOTA T100 V6 3.4L 94-98 TOYOTA 4Runner V6 3.4L 96-01	120	13405-62030 4160168900
TYF503			TOYOTA	KTY03	GEO Prizm L4 1.6L 93-97 GEO Prizm L4 1.8L 93-97 TOYOTA Corolla L4 1.6L 93-97 TOYOTA Corolla L4 1.8L 93-97 TOYOTA Celica ST L4 1.8L 94-97	106	13405-15090
TYF504			TOYOTA	KTY13	TOYOTA Tacoma DLX L4 2.4L 95-04 TOYOTA Previa DX L4 2.4L 91-94	115	13405-75030
TYF505			TOYOTA	16047 16073	TOYOTA Camry L4 2.0L 89-01 5 Vel TOYOTA MR2 L4 2.2L 91-95 5 Vel. TOYOTA Celica L4 2.2L 89-99 TOYOTA Celica L4 2.0L 89-99 TOYOTA Camry L4 2.2L 96-01 TOYOTA Solara L4 2.2L 99-02	120	13405-74120 13405-03010 13405-74031 13405-74030
TYF506			TOYOTA	16064 16070	TOYOTA Tercel L4 1.5L 87-98 Exc. EZ TOYOTA Paseo L4 1.5L 92-97	107	"1340511041 4160154900"





VOLANTES MOTRICES



# Item	A	B	Marca	ProKit #	Aplicación	Dientes	OE #
TYF507			TOYOTA	16057 16058 16059	TOYOTA Pickup DLX L4 2.4L 93-95 5 Vel. TOYOTA Pickup SR5 L4 2.4L TURBO 85-88 5 Vel. TOYOTA 4Runner SR5 L4 2.4L 1987 TOYOTA 4Runner SR5 L4 2.4L 92-95	115	13405-35030
TYF508			TOYOTA	16070	CHEVROLET Nova L4 1.6L 85-88 TOYOTA Corolla 1.6L 84-92 TOYOTA MR2 GT L4 1.6L 85-87 TOYOTA Starlet L4 1.3L 1984 GEO Prizm L4 1.6L 89-92	106	1340515030
TYF509			TOYOTA	TYK1506 TYK1507	TOYOTA Corolla XRS L4 2.4L 09-10 TOYOTA Matrix S & XRS L4 2.4L 09-13 TOYOTA Camry L4 2.4L 02-09 TOYOTA Camry L4 2.5L 10-11 TOYOTA Camry V6 3.0L 04-06 TOYOTA Camry V6 3.3L 04-06 TOYOTA Camry V6 3.3L 07-10 TOYOTA Scion tC L4 2.4L 05-10 TOYOTA Scion tC L4 2.5L 11-16 TOYOTA Scion xB L4 2.4L 08-15 TOYOTA Rav 4 L4 2.0L 01-03 TOYOTA Rav 4 L4 2.4L 04-05 TOYOTA Solara L4 2.4L 02-08 TOYOTA Solara V6 3.3L 04-08	120	13405-28020 4160221900
TYF510			TOYOTA	TYK1503 TYK1515	TOYOTA Tacoma V6 4.0L 05-13 TOYOTA Tundra V6 4.0L 05-06 TOYOTA FJ Cruiser V6 4.0L 07-13	129	13405-31080 4160230900
TYF511			TOYOTA	16090	TOYOTA Hiace L4 2.7L 06-15 5 Vel. TOYOTA Hilux L4 2.7L 06-15 5 Vel. TOYOTA 4Runner L4 2.7L 96-00 TOYOTA T100 L4 2.7L 94-98 TOYOTA Tacoma L4 2.7L 95-04	115	13405-75040
TYF512			TOYOTA	TYK1518	TOYOTA Corolla L4 1.8L 09-14 TOYOTA Matrix L4 1.8L 09-14 TOYOTA Scion XD L4 1.8L 08-14	106	13405-37050 1340537051 4160212900
TYF513			TOYOTA	KTY14	TOYOTA Matrix XRS L4 1.8L 03-08 PONTIAC Vibe L4 1.8L 03-06 TOYOTA Celica L4 1.8L 00-05 TOYOTA Corolla XRS L4 1.8L 03-06 TOYOTA Corolla S L4 1.8L 05-06	106	88969561 13405-88600 4160222900

VOLANTES MOTRICES



# Item	A	B	Marca	ProKit #	Aplicación	Dientes	OE #
TYF518			TOYOTA	KTY16	TOYOTA Tacoma L4 2.7L 05-18	115	13405-75060
TYF520			TOYOTA	16057 16058 16059 KTY02 16007 16084 16018	TOYOTA 4Runner L4 2.4L 84-88 No Turbo TOYOTA 4Runner L4 2.4L 86-95 TOYOTA Pickup L4 2.4L 81-88 2.4L No Turbo TOYOTA Pickup L4 2.4L 86-95 TOYOTA Pickup 1985 2.4L Turbo TOYOTA Van L4 2.2L 88-89	-	13405-35021 4160144900

VOLANTES MOTRICES HD



EXEDY #	A	B	Marca	HD ProKit #	Aplicación	Ø / Dientes & Birlos	OE #
HNF100			HINO	HNK1006EX HNK1007EX	HINO Serie 500 - 1524 L6 7.7L TURBO DIESEL 09-19 6 Vel. HINO Serie 500 - 1724 L6 7.7L TURBO DIESEL 09-19 6 Vel. HINO Serie 500 - 1727 L6 7.7L TURBO DIESEL 09-19 6 Vel. HINO Serie 500 - 2627 L6 7.7L TURBO DIESEL 09-19 6 Vel. HINO Serie 500 BUS - BF1524M L6 7.7L TURBO DIESEL 2018-> 9 Vel.	380 * 129 * 8	13450-E0B61
HNF101			HINO	TYK1519EX	HINO Serie 300 414 L4 4.0L TURBO DIESEL 09-11 5 Vel. HINO Serie 300 514 L4 4.0L TURBO DIESEL 12-19 5 Vel. HINO Serie 300 614 L4 4.0L TURBO DIESEL 09-11 5 Vel.	300 * 129 * 6	13450-E0D51 13450-E0D50
HNF102			HINO	HNK1001	HINO Serie 300 - 616 L4 4.0L TURBO DIESEL 09-19 5 Vel. HINO Serie 300 - 716 L4 4.0L TURBO DIESEL 2008 6 Vel. HINO Serie 300 - 816 L4 4.0L TURBO DIESEL 2008 6 Vel.	325 * 129 * 6	13450-E0021
HNF103			HINO	HNK1002	HINO Serie 300 - 716 L4 4.0L TURBO DIESEL 09-19 6 Vel. HINO Serie 300 - 816 L4 4.0L TURBO DIESEL 09-19 6 Vel.	325 * 129 * 8	13450-E0L60 13450-E0L50
ISF100			ISUZU	ISK1011EX	ISUZU ELF 400 L4 5.2L TURBO DIESEL 07-19 6 Vel. ISUZU ELF 450 L4 5.2L TURBO DIESEL 07-19 6 Vel. ISUZU ELF 500 L4 5.2L TURBO DIESEL 07-19 6 Vel. ISUZU ELF 600 L4 5.2L TURBO DIESEL 07-19 6 Vel. ISUZU ELF 600-BUS L4 5.2L TURBO DIESEL 07-19 6 Vel.	325 * 138 * 8	8-97326-2-272
ISF101			ISUZU	ISK1013EX	ISUZU Forward FRR 800 L4 5.2L TURBO DIESEL 10-13 6 Vel.	350 * 143 * 8	8-98056355-2 8-98056355-1 8-98056355-0 8-97024380-0 8-97376133-0
ISF102			ISUZU	ISK1010EX	ISUZU ELF 200 L4 3.0L TURBO DIESEL 09-19 5 Vel. ISUZU ELF 300 L4 3.0L TURBO DIESEL 08-19 5 Vel.	325 * 138 * 8	8-98148063-1



GALERÍA KITS DE EMBRAGUE



01033



01034



01037



01040



03028



04005



04019



04049



04064



04077



04082



04087



04088



04089



04100



04104



04105



04108



04121



04122



04124



04128



04129



04130



04131



04132



04133



04134



04137



04142



04143



04154



04154A



04158



04161



04163



04163A



04168



04170



04171



04173



04802



04803



04804



04805FW



05011



05031



05037



05038



05041



05051



05057



05063



05065



05066



05069



05070



05072



05073



05074



05076



05080



05085



05087



05088



05089



05091



05092



05100



05104



06009



06021



06040EXMX



06042



06044



06045



06054



06059



07016



07042



07054



07056



07057



07075



07076



07077



07093



07094



07096



07097



07099



07100B



07114



07129



07132



07136



07137



07139



07144



07807CSC



07808FW



07953PFW



08012



08013



08014



08022



08806FW



10025



16058



16059



16062



16069



16073



16082



16087



16090



17010



17012



17013



17023



17027 17034 17036 17038



AUK1001 AUK1002 AUK1004 AUK1004EX



AUK1005 AUK1006 BKM1000 BKM1001

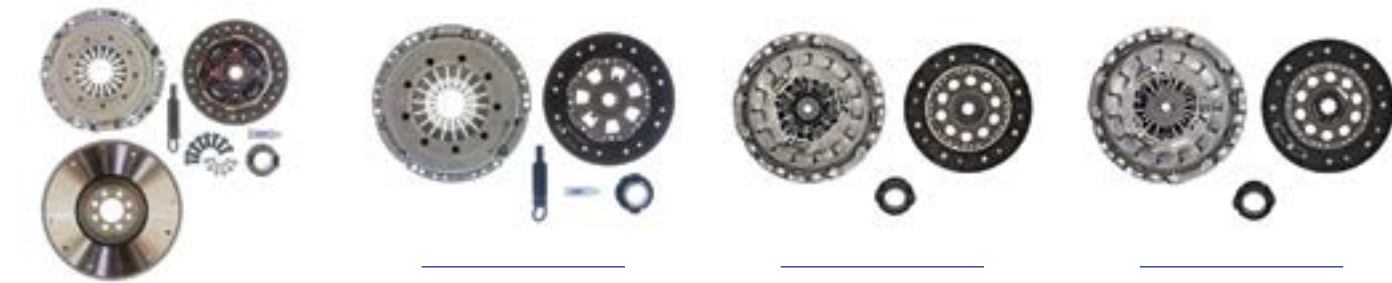

BKM1001FW BKM1003 BKM1005 BKM1006



BKM1010 BKM1011 BKM1012 BKM1013



BKM1014 BKM1015 BKM1016 BKM1017



BKM1018 CRK1000 CRK1001 CRK1004



CRK1005FW CRK1005FWHD CRK1006 CRK1007



CRK1008 CRK1009 CRK1010 CRK1017



08810 FJK1000 FJK1001 FJK1001FW



FMK1000



FMK1004



FMK1005



FMK1007



FMK1008



FMK1010



FMK1011



FMK1012



FMK1016



FMK1018



FMK1019



FMK1020



FMK1026



FMK1027E



FMK1029EX



FMK1030EXMX



FMK1031EX



FMK1032



FMK1034



FT803203U



FT804203U



FTK1000EX



FTK1001EX



FTK1002EX



FTK1003EX



FTK1004EX



GMK1000



GMK1004



GMK1009



GMK1010



GMK1015



GMK1017



GMK1018



GMK1019



GMK1036



GMK1037



GMK1042EX



GMK1047EX



GMK1048EX



GMK1050EX



HCK1000



HCK1002



HCK1004



HCK1005



HCK1006



HCK1007



HCK1008



HCK1009



HCK1010



HCK1011



HCK1013EX



HCK1014



HCK1015



HNK1001



HNK1002



HNK1005EX



HNK1006EX



HNK1007EX



HYK1000



HYK1001



HYK1002



HYK1002FW



HYK1003



HYK1005



HYK1009EX



HYK1010EX



HYK1011EX



HYK1014EX



HYK1015EXMX



HYK1016EX



ISK1002



ISK1003EX



ISK1009EX



ISK1010EX



ISK1011EX



ISK1012EX



ISK1013EX



ISK1014EX



KBM11



KCH05



KDG01



KDG02



KFM01



KFM02



KFM06CSC



KFM09



KFM16



KFM18



KFM21



KGM04



KGM05



KGM08



KGM10



KGM17



KGM21



KGM40



KGM42



KGM44



KHC05



KHC08



KHC09



KHC10



KHY01



KIK1002



KIK1004



KIS01



KIS05



KJP01



KJP02



KJP03



KKI01



KKI02



KMB02



KMB03



KMF01



KNS02



KNS03



KNS04



KNS06



KNS07



KNS10



KPO18



KSB04



KSN03



KSZ04



KTY03



KTY13



KTY14



KVW01



KVW05



MBK1000



MBK1001



MBK1003



MBK1004



MBK1007



MBK1008



MBK1009



MBK1010



MBK1011



MBK1015



MBK1018



MBK1020EX



MBK1021EX



MBK1023



MBK1024EX



MFK1001



MFK1010



MFK1015EX



MFK1016EX



MZK1000



MZK1001



MZK1003



MZK1005



MZK1006



MZK1008



MZK1009



MZK1010



MZK1012



MZK1013EX



MZK1018EX



MZK1019EX



NSK1000



NSK1000FW



NSK1002



NSK1003



NSK1005



NSK1006



NSK1007



NSK1008



NSK1009



NSK1010EX



NSK1012EX



NSK1013EX



NSK1014HDEX



NSK1024FW



NSK1025EXMX



NSK1026FW



NSK1027EX



NSK1028EX



NSK1029EX



NSK1031EX



NSK1032EX



NSK1033EX



NSK1034EX



NSK1035EX



NSK1036EX



NSK1037



NSK1039EX



NSK1040EX



NSK1041EX



NVK0001EX



NVK1001EX



OPK1002



PGK1000EX



PGK1001EX



PGK1002EX



RNK1000EX



RNK1001EX



SK01H



SK01T



SK03H



SK03T



SZK1000



SZK1001



SZK1003



SZK1004EX



SZK1005EX



SZK1007EX



SZK1008EX



SZK1009EX



SZK1010EX



SZK1011EX



SZK1012EX



SZK1013EX



TYK1501



TYK1502



TYK1503



TYK1504



TYK1506



TYK1515



TYK1517EX



TYK1518



TYK1515



TYK1520EX



TYK1521EX



TYK1522



TYK1523EX



TYK1524EX



TYK1525EX



VWK1001



VWK1002



VWK1004



VWK1005



VWK1006



VWK1007



VWK1008EX



VWK1009EX



VWK1010EX



VWK1011EX



08957

Cómo hacerlo bien la primera vez...
INSTRUCCIONES DE AJUSTE:
INSTALANDO SU NUEVO EMBRAGUE EXEDY

El incumplimiento de estas instrucciones al colocar su Embrague EXEDY, anulará cualquier garantía.

- Haciéndolo bien la primera vez. Es vital diagnosticar la causa del mal funcionamiento del embrague antes de reemplazar el mismo, por ejemplo, revisar el sistema hidráulico – movimiento libre del rodamiento - cable de embrague, fugas de aceite y revisar cualquier señal de polvo rojo cuando el embrague anterior sea removido. Cualquiera o todos estos problemas deben ser corregidos antes de instalar un embrague nuevo.
- Asegúrese de que el embrague suministrado es correcto para la aplicación. Si no está seguro, consulte su Catálogo de Embragues EXEDY o a su proveedor, ya que instalar un embrague de la aplicación incorrecta anulará la garantía.
- El volante de inercia debe ser reemplazado o mecanizado como se muestra en la Figura 2 (máximo 0.03 pulgadas) o la garantía será anulada. Revise el rodamiento de la espiga o el rodamiento piloto y reemplace si es necesario. Tenga en cuenta que los ruidos del rodamiento piloto son más notorios cuando el motor y los sistemas de transmisión están fríos, en particular, por la mañana.
- Antes de instalar, revise el embrague y asegúrese de que no presente algún daño a causa del proceso de envío. A continuación, limpie las estrías del eje de transmisión principal de la caja de cambios, después revise que el disco de embrague se deslice libremente en el eje. Engrase ligeramente las estrías del eje con grasa de punto de fusión alta. Siempre asegúrese que la carcasa sea desengrasada y esté libre de cualquier polvo, y que las fibras del embrague desgastado sean removidas. Si el embrague es de tamaño grande y de tipo halar, revise el ID (interior) del cabezal del rodamiento para verificar el tamaño correcto de la ranura antes de la instalación. La falta de lubricación; estrías secas no permitirá desenganchar los engranajes y también provocará el arrastre del embrague. Nunca se debe sobre lubricar/engrasar el estriado de su disco de embrague ya que la grasa salpicará durante la rotación del motor y el embrague. La contaminación de grasa/aceite en el material de fricción del disco del embrague hará que el embrague se deslice.
- Revise la horquilla del embrague de rajaduras, revise el cable del embrague de signos elásticos y revise el rodamiento del embrague de cualquier desgaste. Engrase siempre ligeramente el diámetro exterior del tubo. Esto permitirá un deslizamiento suave del portador de rodamiento. Revise siempre el rodamiento en la horquilla del embrague después de instalar éste en él. Mueva la horquilla hacia adelante y hacia atrás (en las dos direcciones) para cerciorarse de que el rodamiento esté asegurado y no se caiga en ninguna parte (horquilla de embrague o carcaza) antes de la reinstalación de la caja de cambios.
- Coloque la prensa de embrague sobre el disco de embrague, después de revisar que el disco este colocado correctamente alrededor y la sección del cubo del disco no se caiga en la prensa de embrague o Volante de Inercia. Una herramienta adecuada de alineación del embrague asegurará una alineación correcta, facilitará la instalación y evitará daños en las estrías. (Las rebabas en las estrías son la mayor causa en el desacoplamiento del engranaje). Asegúrese de que los pernos del Volante de Inercia estén alineados con la prensa de embrague. Ajustar los pernos en un patrón desigual en algunos casos podría hacer que el puntal de la palanca se desprenda de la pieza fundida de la placa de presión.
- Cuando la prensa del embrague haya sido ajustada y asegurada firmemente al volante de inercia, asegúrese de que las puntas del diafragma (en el caso de un embrague tipo halar, las puntas de la palanca de liberación) estén en una posición paralela o ligeramente hacia arriba (ver Fig. 3) y no pase sobre el centro de la posición paralela
- Vuelva a armar la caja de cambios, teniendo precaución de no doblar el disco de embrague. Nunca cuelgue la caja de cambios del disco de embrague ni utilice ninguna fuerza para alinear el eje de la caja de cambios.
- Verifique que todos los agujeros del pasador estén en la posición correcta y apriete los tornillos de la carcaza. Asegúrese de que no haya suciedad o material extraño entre las superficies del acoplamiento.
- Realice los ajustes de embrague según las especificaciones del fabricante de vehículo y siempre reinicie la varilla de empuje del cilindro maestro para obtener una posición cómoda de liberación del pedal (el hecho de que el embrague se acerque lo más posible al piso evita el estremecimiento del embrague y, en la mayoría de los casos, es preferible para los conductores del vehículo) Tenga en cuenta que la posición de la punta del diafragma ha cambiado con la instalación del nuevo embrague.
- Siempre revise el cable del embrague si no logra el desenganche cuando se instala un nuevo embrague. Comience su proceso de verificación reemplazando el cable. Si se trata de un embrague hidráulico, empiece con revisar el cilindro maestro de embrague y el cilindro esclavo del embrague, asegurándose de que no haya aire en el sistema. Esto es esencial para obtener un máximo movimiento para el desacoplamiento.
- Pruebe el vehículo en carretera y nunca abuse de un embrague recién instalado. Permita 750 millas de interrupción y siempre ajuste el pedal de su nuevo embrague a 750 millas y 1500 millas. De ahí en adelante, ajuste cada 10,000 millas.

ADVERTENCIA: No utilice los embragues EXEDY en ninguna situación en la que las RPM del motor puedan exceder las especificaciones del fabricante: la placa de presión podría explotar inesperadamente ocasionando lesiones graves o la muerte a los ocupantes del vehículo y transeúntes. La cubierta del embrague y la carcaza no protegen contra explosiones de la placa de presión. Consulte el Catálogo de Aplicaciones para el ajuste correcto.

Para aplicaciones de tipo performance/sport siempre utilice un Embrague EXEDY Sport para su reemplazo.

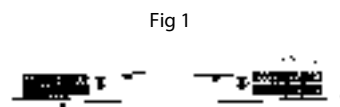

Fig 1

La superficie abombada puede parecer lisa pero desigual

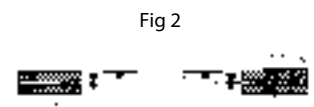
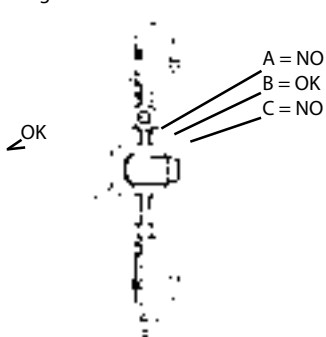

Fig 2

Superficie plana bien mecanizada

Fig 3



Mayor Plusvalía & Rentabilidad para su Negocio

ACÉRCATE A NOSOTROS...



El contenido de este catálogo no contiene valor legal y la información contenida sigue propósitos informativos únicamente.

EXEDY México Aftermarket Sales, S.A. de C.V. se deslinda de cualquier responsabilidad ligada a esta publicación.

Todos los derechos reservados. Prohibida su copia, distribución, reproducción, disposición al público o cualquier otra publicación de este catálogo completo o por partes sin el consentimiento escrito de EXEDY México Aftermarket Sales, S.A. de C.V.

EXEDY Copyright ©

EXEDY

Excellent & Dynamic

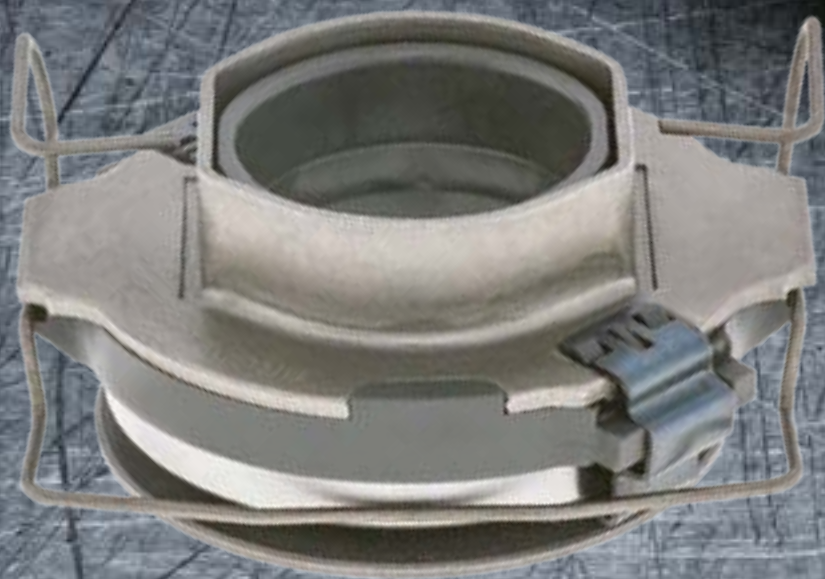

EXEDY México Aftermarket Sales

Vía Adolfo López Mateos 9
Naucalpan, Estado de México
C.P. 53120, México
Tel. + 52 (55) 5572-5127